



DCell



DSC

## DCell & DSC

### Strain Gauge or Load Cell Embedded Digitiser Module CANopen® - 2<sup>nd</sup> Generation

Software Version 3 onwards



*User Manual*  
[www.mantracourt.co.uk](http://www.mantracourt.co.uk)

**ME** mantracourt

Contents	
<b>Chapter 1 Introduction</b>	<b>4</b>
Overview	4
Key Features	4
Special Facilities	5
Version 3 Additions and Enhancements	5
The Product Range	6
Which Device To Use	6
Additional DCell & DSC Variants Available	6
Some Application Examples	7
<b>Chapter 2 Getting Started with the Evaluation Kit</b>	<b>8</b>
The Evaluation Kit	8
Contents	8
Checking the Device Type	9
Connecting Up The Evaluation Kit	9
Initial Checks	9
Instrument Explorer	9
What Can Instrument Explorer Do?	9
Installing Instrument Explorer	9
Running the Instrument Explorer Software	10
Instrument Explorer Icon	10
Instrument Settings	11
Viewing Device Data	12
Instrument Explorer Parameter List	12
Connecting a Load Cell	13
DSJ1 Evaluation Board Sensor Connections	14
Performing A System Calibration	15
<b>Chapter 3 Explanation of Category Items</b>	<b>19</b>
Information	19
Software Version, VER	19
Serial Number, SERL and SERH	19
Strain Gauge	19
mV/V output, MVV	19
Nominal mV/V level, NMVV	19
mV/V Output In Percentage Terms, ELEC	19
Temperature Value, TEMP	19
Output Rate Control, RATE	19
Dynamic Filtering, FFST and FFLV	20
Cell	21
Temperature Compensation In Brief	21
Cell Scaling, CGAI, COFS	21
Two Point Calibration Calculations and Examples	22
Calibration Methods	22
Cell Limits, CMIN, CMAX	23
Linearisation In Brief	23
System	23
System Scaling, SGAI, SOFS	23
Example of calculations for SGAI and SOFS	24
System Limits, SMIN, SMAX	24
System Zero, SZ	25
System Outputs, SYS, SOUT	25
Reading Snapshot, SNAP, SYSN	25
Control	25
Shunt Calibration Commands, SCON and SCOF	25
Digital Output, OPON and OPOF	25
Flags	25
Diagnostics Flags, FLAG and STAT	25
Latched Warning Flags (FLAG)	25

Meaning and Operation of Flags.....	26
Dynamic Status Flags (STAT).....	27
Meaning and Operation of Flags.....	27
Output Update Tracking.....	27
User Storage.....	28
USR1...USR9.....	28
Reset.....	28
The Reset command, RST.....	28
WARNING: Finite Non-Volatile Memory Life.....	28
<b>Chapter 4 The Readings Process.....</b>	<b>29</b>
Flow diagram.....	29
Cell and System Scaling.....	30
Calibration Parameters Summary and Defaults.....	31
<b>Chapter 5 Temperature Compensation.....</b>	<b>32</b>
Purpose and Method of Temperature Compensation.....	32
Temperature Module Connections and Mounting (DTEMP).....	32
Control Parameters.....	33
Internal Calculation.....	33
The Temperature Measurement.....	34
How to Set Up a Temperature Compensation.....	34
Parameter Calculations.....	35
<b>Chapter 6 Linearity Compensation.....</b>	<b>36</b>
Purpose and Method of Linearisation.....	36
Control Parameters.....	36
Internal Calculation.....	36
How to Set Up Linearity Compensation.....	37
Parameter Calculations and Example.....	37
<b>Chapter 7 Self-Diagnostics.....</b>	<b>39</b>
Diagnostics Flags.....	39
Diagnostics LED.....	39
<b>Chapter 8 CANopen® Communication Protocol.....</b>	<b>40</b>
CANopen® Features Support Summary.....	40
Object Dictionary Summary.....	41
Error Management.....	42
Communications Controls.....	42
Data Type Conversions and Rounding.....	43
<b>Chapter 9 Object Dictionary.....</b>	<b>44</b>
Communications Profile Area.....	44
Device Description and Communication Specific.....	44
Transmit PDO Operation Specific.....	45
Transmit PDO Mapping Specific.....	46
Manufacturer Specific Area.....	47
<b>Chapter 10 Installation.....</b>	<b>48</b>
Before Installation.....	48
Physical Mounting.....	48
Electrical Protection.....	48
Moisture Protection.....	48
Soldering Methods.....	49
Power Supply Requirements.....	49
Cable Requirements.....	49
Strain Gauge input (DSC).....	49
Power and Communication.....	49
Temperature Sensor.....	49
Identifying Strain Gauge Connections.....	50
DCell Input Connections.....	50
DSC Input Connections.....	50
Identifying Bus-End Connections.....	50
DCell Bus Connections.....	50

DSC CAN Versions-Bus Connections .....	51
Strain Gauge Cabling and Grounding Requirements .....	51
DCell Strain Gauge Wiring .....	51
DCell Strain Gauge Wiring Arrangement .....	51
Key Requirements .....	51
DSC Strain Gauge Cabling Arrangement .....	52
Key Requirements .....	52
Communications Cabling and Grounding Requirements.....	53
DCell Power and Communications Wiring .....	53
DCell Bus-End Arrangement.....	53
DSC4 Versions- Power and Communications Wiring.....	54
DSC4 Versions-Bus-End Arrangement .....	54
Key Requirements .....	54
Suitable Cable Types .....	54
DCell/DSC CAN Bus Cable .....	54
CAN Bus Connections for Multiple DCells .....	55
CAN Bus Connections for Multiple DSC Versions.....	55
Key Requirements .....	56
Bus Layout and Termination .....	56
Loading .....	56
Strain Gauge Sensitivity Adjustment (DSC ONLY) .....	56
Identifying the DSC 'Rg' Resistor .....	56
<b>Chapter 11 Troubleshooting .....</b>	<b>58</b>
LED Indicator .....	58
No Communications .....	58
Bad Readings .....	58
Unexpected Warning Flags .....	59
Problems with Bus Baud Rate.....	59
Recovering a "lost" DCell/DSC .....	59
Resetting to default ID.....	59
First Command .....	59
Second Command.....	59
<b>Chapter 12 Specifications.....</b>	<b>60</b>
Technical Specifications DSC/DCELL High Stability.....	60
Technical Specifications DSC/DCell Industrial Stability.....	61
Mechanical Specification for DSC .....	62
Mechanical Specification for DCell .....	62
CE Approvals.....	62
Warranty .....	63

# Chapter 1 Introduction

This chapter provides an introduction to DCell/DSC products, describing the product range, main features and application possibilities.

## Overview

The DCell and DSC products are miniature, high-precision Strain Gauge Converters; converting a strain gauge sensor input to a **CANopen®** output. They allow multiple high precision measurements to be made over a low-cost 2-wire link. Outputs can be accessed directly by PLCs or computers, or connected via various types of network, all without compromising accuracy.

The device is configurable using a **CANopen®** configuration tool.

## Key Features

### Ultra-miniature

The DCell 'puck' format can be fitted inside most load cell pockets, and similar restricted spaces. The DSC cards are similarly very small, optimised for mounting as a component onto custom PCBs.

### High-precision Industrial Version.

**25ppm** basic accuracy (equates to 16 bit resolution)

### High-precision High Stability

**5ppm** basic accuracy (equates to 18 bit resolution) with comparable stability - far exceeds standard instrument performance.

### Low-power

Low-voltage DC supply (5.6V min), typically 40mA for RS485 and 52mA for RS232 (including 350R strain gauge).

### Adjustable sensitivity

Configured for standard 2.5mV/V full-scale strain gauges as supplied.

A single additional resistor configures the input between 0.5 and 100 mV/V full-scale.

### Temperature sensing and compensation (optional)

An optional temperature sensor module is available and advanced 5-point temperature-compensation of measurement.

### Linearity compensation

Advanced 7-point linearity compensation.

### CAN Output

Lower-cost cabling, improved noise immunity, and longer cable runs with no accuracy penalty.

Device addressing allows up to 127 devices on a single bus, drastically reducing cabling cost and complexity.

Two-way communications allow in-situ re-calibration, multiple outputs and diagnostics.

No separate measuring instruments needed.

### Digital calibration

Completely drift-free, adjustable in-system and/or in-situ via standard communications link.

Two independent calibration stages for load cell-and-system-specific adjustments.

Programmable compensation for non-linearity and temperature corrections.

Calibration data is also transferable between devices for in-service replacement.

### Self-diagnostics

Continuous monitoring for faults such as strain overload, over/under-temperature, broken sensors or unexpected power failure.

All fault warnings are retained on power-fail.

## ***Special Facilities***

### **Output Capture Synchronisation**

A single command instructs all devices on a bus to sample their inputs simultaneously, for synchronised data capture.

### **Output Tare Value**

An internal control allows removal of an arbitrary output offset, enabling independent readings of net and gross measurement values.

### **Dynamic Filtering**

Gives higher accuracy on stable inputs, without increased settling time.

### **Programmable Output Modes**

Output rate control enables speed/accuracy trade-off.

ASCII output version provides decimal format control and continuous output mode for 'dumb terminal' output.

### **Unique Serial Number**

Every unit carries a unique serial-number tag, readable over the communications link.

### **Communications Error Detection**

CAN transmit and receive error counts along with CAN bus status can be read from the device.

### **External Temperature Sensing (optional)**

An external temperature module for improved accuracy (especially tracking changing temperature conditions).

### **Software Reset**

A special communications command forces a device reboot, as a failsafe to ensure correct operation.

## ***Version 3 Additions and Enhancements***

The following are an outline only more detail will be found further on in this manual

### **DCell**

- Easy mounting via a 2mm screw
- Connection via solder holes to either side of PCB
- Lower profile, dual PCB construction

### **DSC**

- Additional I/O
- Easier shielding connection at load cell connector end

### **DCell & DSC**

- Bit rates to 1 Mbps
- Higher sampling rate. Sampling to 200Hz can now be achieved. Also more sampling rates are available as follows 1, 2, 5, 10, 20, 50, 60, 100 & 200Hz.
- Lower cost. With new technology and further use of miniaturisation the cost is now lower.
- Real mV/V calibration. Instead of % full scale the base measurement is in mV/V and is factory calibrated to within 0.1%. the % of FS output "ELEC" is still available.
- Extreme Noise Immunity, 5 x heavy industrial level.
- Diagnostics LED. An LED is used to indicate that the device is powered and working correctly. The LED is also used to indicate which protocol the device is.
- Remote shunt cal. A 100K 1% 50ppm/Deg C resistor can be switched across the bridge to allow load cell integrity to be established.
- Peak & Trough Measurements. Added to allow the faster rates to hold a peak or trough readings. These are stored in volatile memory & are therefore reset on power up.
- Programmable dynamic filtering. The filtering is the same as used on Version 2 but with the advantage of being able to set the characteristics using the communications.
- Wide Operating Voltage. The operating voltage is now 5.5 to 18V allowing the device to be powered from a wider range of available system supplies.
- DC Excitation. DC excitation has now been employed allowing longer cable lengths for the load cells which is particularly useful for DSC. This is a 4-wire measurement.

- Scaling implementation has been changed for both “CELL” and “SYS”. The gain is applied before the offset thus following the more standard approach. This allows for an offset change to be made easily as the offset is not a component of gain.

## The Product Range

Devices are available in two physical formats:

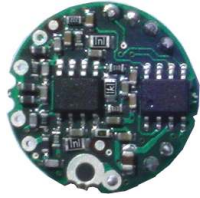

The DCell (puck) products consist of a Digital Strain Gauge Signal Conditioner with CAN bus output in double sided component population format.

This is suitable for installation in very small spaces, including load cell pockets.

External connections are made by wiring to through hole pads.

Mounting is via a 2mm mounting hole to accept M2 screw or American equivalent #0-80. Important Note: DO NOT USE #2 screw size.



The DSC (card) products are very similar to the DCell but in a different physical form for mounting stand-alone or on a board.

External connections are via header pins which can plug into connectors, or be soldered to wires or into a host PCB. DSC has an open collector output and volt free digital input.

## Which Device To Use

It is important to select the correct product for your application.

First choose DCell or DSC based on your physical installation needs

### Common Features

Both physical formats offer identical control and near-identical measurement performance

### Differences

Only the DSC (card) is available with digital Input & output.

### Special Aspects To Consider

The DCell fits neatly into a strain gauge pocket

The DSC lends itself to PCB mounting

## Additional DCell & DSC Variants Available

A separate variant is available with RS232 or RS485 output. Refer to DCell & DSC CAN - 2<sup>nd</sup> Generation - Manual. (These variants are sufficiently different to require their own manuals)

The following order codes are supported by an earlier version manual ‘DCell & DSC Version 2’

DLCPKASC, DLCPKMAN, DLCPKMOD, DSC2AS, DSC2MA, DSC2MB, DSC4AS, DSC4MA, DSC4MB

## ***Some Application Examples***

### **Simple Distributed Measurement**

Pressure loads are taken at a number of key points in a manufacturing process, distributed over a large area. Each pressure sensor contains a DCell unit, and all the sensors are connected by a single cable carrying power and CAN communications. A central PC allows continuous display, monitoring and logging of all values from a central control room. This displays a control-panel and current display window, and logs information to an Excel spreadsheet for future analysis.

Further monitoring checks and displayed information can easily be added when required to the system where up to 127 'nodes' can be installed.

### **Low Cost Dedicated Weighing Station**

A basic load cell weighing-pad device has a cable leading to a wall mounted weight display.

### **Digital Load Cell**

Load cell products are offered with a high-precision digital communications option.

A DCell is fitted into the gauge pocket of each load cell in manufacture. During product testing, each unit undergoes a combined load test and temperature cycle. Each unit is then programmed with individually calculated gain, offset, linearity and temperature compensation tables. All units perform to a very tight specification without the use of any trimming components.

### **High Reliability Load sensing**

A road bridge has a dedicated load monitoring and active control computer system. System calibration adjustments are only established during construction, so sensors must be replaceable without recalibration.

Each load monitoring point has a digital load cell fitted, with calibration values set during construction. Self-diagnostics aid detection of failures.

When a failed load cell is replaced it will produce identical force measurements. The old load cell set-up data values are programmed into the separate user-level calibration store in the unit, to produce an identically performing replacement.

### **Load Balance Monitor**

A lorry loading weighpoint monitors left/right load balance and sounds a warning if loading is too uneven for safety.

A drive-on weighing platform is provided with load cells at each of four corners. Each cell is wired to a DSC unit, and these are cabled to a 3<sup>rd</sup> party LCD display and control unit, producing a complete turnkey system. A digital I/O card is wired to the same bus to control the warning alarm. Application software running on the control unit provides a % left/right balance readout with a graphical tipping display, and a total weight indication.

The balance indication is calculated by comparing the different corner readings. If it exceeds a programmed limit, a command to the I/O card turns the relay on.

Total weight is calculated by summing the individual results mathematically.

Automatic re-zeroing occurs when the total is near zero for more than a few seconds.

A control button enables a set-up mode for recalibration (protected by operator password), which displays individual readings and total. Corner compensation can be checked by observing the changing total as a weight is moved around. Simple button presses control two point recalibration for any cell.

## Chapter 2 Getting Started with the Evaluation Kit

This chapter explains how to connect up a DCell/DSC for the first time and how to get it working. For simplicity, this chapter is based on the standard DCell/DSC Evaluation Kit, which contains everything needed to communicate with a puck or card from your PC.

It is advised that first time users wishing to familiarise themselves with the product use the Mantracourt Evaluation Kit. This provides a low cost, easy way to get started.

If you do not have an Evaluation Kit, the instructions in this chapter mostly still apply, but you will need to wire up the device (and possible bus-converter) and have some means of communicating with it.

### The Evaluation Kit

#### Contents

- An Evaluation PCB (DSJ1) which comprises of
  - A 8 way screw connector for the strain gauge & Temperature sensor
  - A 5 way screw connector for power & CAN comms
  - A 9 way 'D'Type for direct CAN (limited to 500Kbps)
  - Link headers for CAN, RS232 or RS485 comms selection
  - Terminating resistor for CAN & RS485
  - LED for power indication
  - LED for digital output (DSC only)
  - Push Switch for digital input (DSC only)
- An Evaluation DCell or DSC of your choice
- A CD ROM containing Instrument Explorer software
- A 9 way 'D'Type extension lead
- A USB-CAN converter
- DTEMP temperature sensor for temperature compensation evaluation



Other Things you will need.

- A regulated power supply, capable of providing 5.6 -18V at 100mA
  - A PC running Windows 98 or above, with a spare USB port and 45Mb free disk space
- and, ideally**
- A strain gauge, load cell or simulator, 350-5000 ohms impedance.

## Checking the Device Type

For a DCell, the Product Code is one of the following 2 types

DLCSOP DLCHCOP	Industrial Stability CANopen® output High Stability CANopen® output
-------------------	--

For a DSC card, the Product Code is one of the following 2 types

DSCSOP DSCHCOP	Industrial Stability CANopen® output High Stability CANopen® output
-------------------	--

**The CAN bus Identifier ID of a New DCell/DSC device is factory set to 127**

This can be changed using the CANopen® command at Index 2000 subindex 0.

## Connecting Up The Evaluation Kit

Power is supplied to the DSJ1 via the 5 way connector (J1). This is connected to a supply set between 5.6v and 18v DC. The red wire being positive and the black negative. The CAN is connected using the 9 way D-type extension lead to J3 and to the USB-CAN converter.

Ensure LK1 & LK5 are set to "CAN/RS485". Fit LK2 which terminates the CAN bus.

Switch on, the Green Power LED of the DSJ1 should be on.

## Initial Checks

With no load cell connected The LED of the DCell or DSC should flash OFF for 100ms every 0.5s.

Note: If a Load cell is connected and there are no errors then the LED will Flash ON for 100mS then Off for the above period. This being the normal healthy state.

Another check that the device is working okay is by noting the current drawn from the supply, this should be about 40mA.

## Instrument Explorer

Instrument Explorer is Mantracourts own communication interface for our range of standard products. It provides communications drivers for the DCell/DSC products. A complimentary copy is provided on CD-ROM with the DCell/DSC Evaluation Kit. Instrument Explorer can also be downloaded from Mantracourts website.

[http://www.mantracourt.co.uk/software/Instrument\\_Explorer](http://www.mantracourt.co.uk/software/Instrument_Explorer)

Instrument Explorer is a software application that enables communication with Mantracourt Electronics instrumentation for configuration, calibration, acquisition and testing purposes.

The clean, contemporary interface allows full customisation to enable your Instrument Explorer to be moulded to your individual requirements.

## What Can Instrument Explorer Do?

- Save and restore customisable user workspace
- Read and Write individual instrument parameters
- Save and restore parameter configurations
- Log data to a window or file
- Perform calibration and compensation

## Installing Instrument Explorer

Install the Instrument Explorer software by inserting the CD in the CD ROM drive. This should start the 'AutoRun' process, unless this is disabled on your computer.

(If the install program does not start of its own accord, run SETUP.EXE on the CD by selecting 'Run' from the 'Start Menu' and then entering *D:\SETUP*, where *D* is the drive letter of your CD-ROM drive).

The install program provides step-by-step instructions. The software will install into a folder called *InstrumentExplorer* inside the *Program Files* folder. You may change this destination if required. Shortcut icons can be created on your desktop and shortcut bar. After installation you may be asked to restart the computer. This should be done before proceeding with communications.

When given the option to install IXXAT CAN drivers ensure these are selected, which is the default.

### ***Running the Instrument Explorer Software***

Having installed Instrument Explorer you can now run the application, which the rest of this chapter is based around.

From the Windows 'Start' button, select *Programs*, then *Instrument Explorer* or click on the shortcut on your desktop.

### ***Instrument Explorer Icon***



The application should open and look like the following shield shot. Instrument Explorer Window

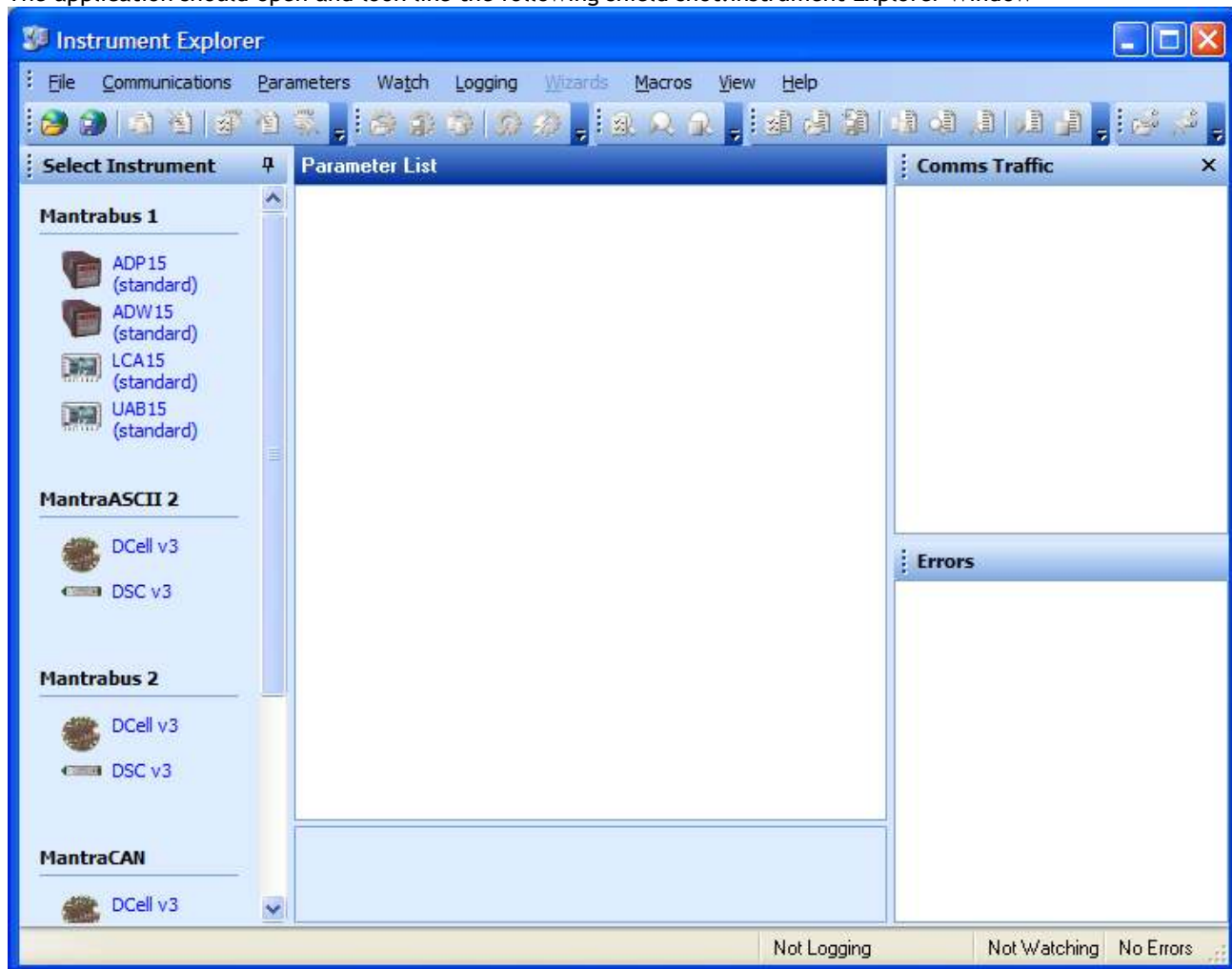

The layout of Instrument Explorers Window and child windows allows the user full customisation to their requirements. If the application show a different arrangement of child windows than the above shield shot then using then load one of the default workspaces as follows:

Click **File** on the menu and select **Open Workspace**. From the file dialogue window select **Layout - Standard.iew**. This will ensure your application layout matches this document.

A list of available instruments is displayed in the Select Instrument pane of Instrument Explorer. Select the relevant device by clicking on the required device icon under the MantraCAN heading.

## ***Instrument Settings***

### **CANopen®**

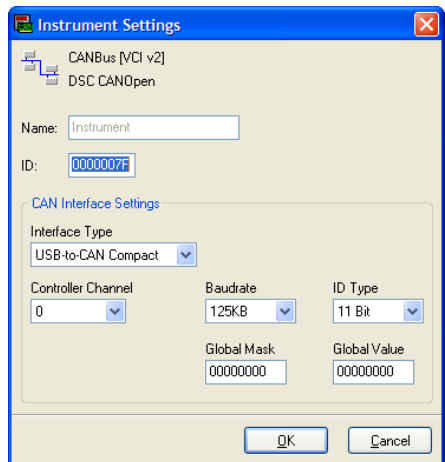

- Select the ID. The factory default is 127 decimal (7F HEX).
- Select the baud rate to which the device is set. The factory default is **125KB**.
- Select the ID type. Default is 11Bit (standard note extended not supported)
- Now click the 'OK' button...

The above assumes factory defaults. If your device is known to have different settings use these instead of the ones stated above.

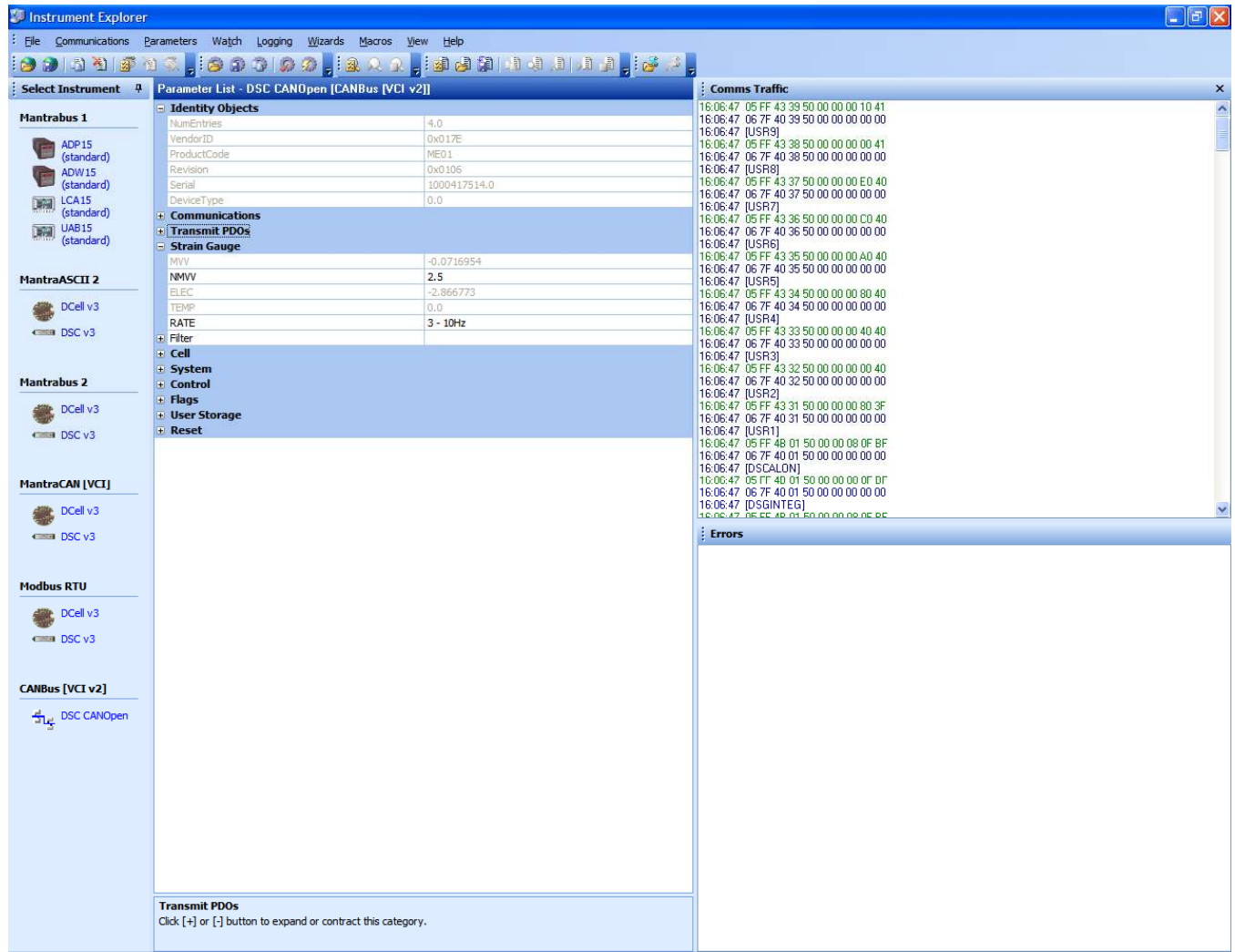

## Viewing Device Data

The following main parameter list should now appear in the central pane.



## Instrument Explorer Parameter List

When an instrument has been selected from the Select Instrument Window this Parameter List window will become populated.

The parameters and commands which are available for the selected device will appear in this list in a structured hierarchic manner enabling the user to expand or contract categories by clicking the  and  buttons on the left of the list.

There are four types of parameters and commands:

**Read/write Numeric** - These parameter values are displayed in the right hand column and can be edited by clicking the value.

The value can then be changed and pressing the Enter key or moving away from the edited value will cause the new value to be written to the device. There are no checks on the data entered and it is up to the user to enter the correct data.

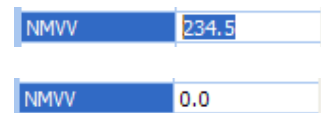

**Read-Only** - These parameter values are displayed 'greyed out' and cannot be changed.

**Read/write Enumerated** - These parameters can only be changed by selecting the new value from a drop down list. Clicking in the right hand column will display a down arrow button which when clicked will display the parameter value options in a list. Note that all enumerated data (apart from on/off) will be displayed with a numeric value, hyphen then the description of the value. The numeric value is the value of the parameter and the description is just there to help.

SerialNumber 0.0

BPS 0

BPS 0

BPS 0

IDSIZE	0 - 20K
CAN Bus	1 - 50K
Streaming	2 - 100K
Information	3 - 125K
VER	4 - 250K
VERSION	5 - 500K
SERL	6 - 800K
	7 - 1M

**Commands** - These commands have 'Click to execute...' displayed in the right hand column. Clicking here will display a button. Click this to issue the command to the device.

RSTEMPUR Click to execute...

RSTEMPUR Click to execute...

As parameters are changed the communications traffic is displayed in the Traffic Pane.

If any errors occur these will be shown in red in the Error Pane. Once an error occurs it will need to be reset before any more communications can take place. Reset errors by either right-clicking the Error Pane and selecting **Reset Errors** from the pop-up menu or select the **Communications** menu and click the **Reset Errors** item.

To manually refresh the parameter list click the button on the toolbar or select **Sync Now** from the **Parameters** menu.

Now you have successfully established communications with your evaluation device the next step is to perform a simple calibration.

## Connecting a Load Cell

You can now connect a strain gauge bridge, load cell or simulator to the DCell/DSC.

A suitable strain gauge should have an impedance of 350-5000ohms and (at least for now) a nominal output of around 2.5mV/V.

## DSJ1 Evaluation Board Sensor Connections

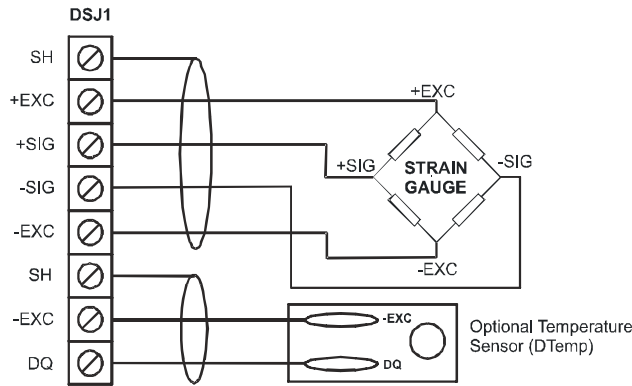

See Chapter 10 for Connection Method to Strain Gauge  
See Chapter 5 for Connections to Temperature Sensor Module

Next Instrument Explorer will set to automatically update dynamic parameters from the device so that we can see values as SYS changing on the shield. To do this either click the  button on the toolbar or click on the **Parameters** menu and select the **Auto Sync** item. Note that these options toggle so be sure to leave your selection in the active state.



From the Parameter List click the  next to the **System** heading to expand this level. The Parameter List should look as follows:

System	
Scaling	
Limits	
SRAW	-2.000592
SZ	0.0
SYS	-2.000592
SOUT	-2.000592
SNAP	Click to execute...
SYSN	0.0
Peak + Trough	

This now exposes more levels that can be expanded as required by clicking the  next to the heading name.

System	
Scaling	
SGAI	1.0
SOFS	0.0
Limits	
SMIN	-100.0
SMAX	100.0
SRAW	-2.000592
SZ	0.0
SYS	-2.000592
SOUT	-2.000592
SNAP	Click to execute...
SYSN	0.0
Peak + Trough	
PEAK	-2.000592
TROF	-2.000719
RSPT	Click to execute...

Dynamic values (such as SYS and SRAW) will now be updating in real-time from the device.

Once you have connected the load cell, you should see 'believable' output values, in the "SYS" parameter displayed in the parameter list pane. These values should correspond to mV/V assuming the device is in it's factory default state.

For diagnostics the device has a of flags. Which is dynamic and will cause an Emergency Telegram to be broadcast on change of state.

## Performing A System Calibration

The values obtained so far are in mV/V units, these are factory calibrated and fixed to within about 0.1% accuracy.

The device also contains two separate user-adjustable calibration parameter groups, these are termed **Cell** and **System**. Cell being used to convert from mV/V to a force and System to convert this force to required engineering units. We shall be using System for the following exercise where we rescale the output value to read in units of your choice, and to calibrate precisely to your load cell / system hardware.

Instrument Explorer provide 'Wizards' to allow quick and simple calibration operations to be undertaken without the use of a calculator. Wizards can be activated by simply selecting the required item from the Wizard menu. Since we are now calibrating at system level we have a choice of two calibration methods:

**Sys Calibration Table** - This technique is used when a manufacturers calibration document is available for the connected strain gauge. This normally gives mV/V to engineering unit values.

**Sys Calibration Auto** - This technique is used when the input can be stimulated with real input values. For example you have access to test weight / forces.

We will now describe each of these techniques with an example.

### Sys Calibration Table

A 10 tonne load cell manufacturer gives the following data:

mV/V output	Force
2.19053	10 tonne
-0.01573	0 tonne

Start the wizard by selecting Sys Calibration Table from the Wizard menu

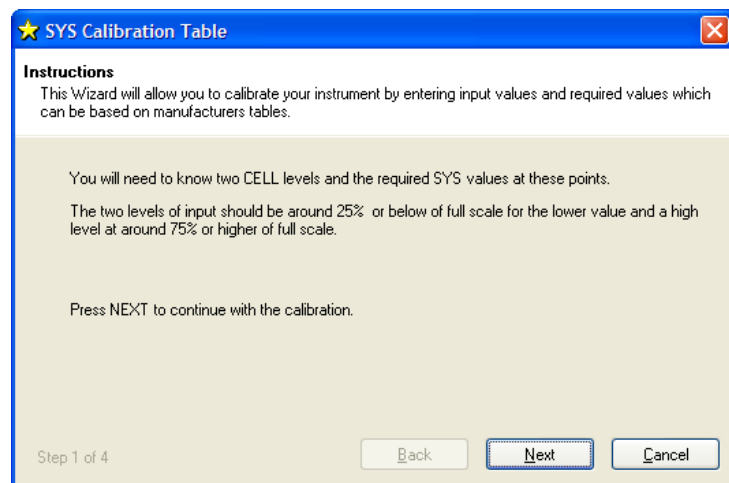

Click the **Next** button and enter the low values as shown below.

★ SYS Calibration Table

**Enter Low Data**  
Enter the low level input value and required output value.

Enter value for CELL at this low input level.    Enter required value for SYS.

-0.01573    0

Step 2 of 4

Back    Next    Cancel

Click the **Next** button and enter the high values as shown below.

★ SYS Calibration Table

**Enter High Data**  
Enter the high level input value and required output value.

Enter value for CELL at this high input level.    Enter required value for SYS.

2.19053    10

Step 3 of 4

Back    Next    Cancel

Click **Next** the following window will be displayed showing the calibrated SYS value which is dependent on the current input values.

★ SYS Calibration Table

**Result**  
Instrument calibration complete. The new calibration values have been calculated and the instrument updated. Click Finish to complete this Wizard.

The display below shows the value of SYS. You can now apply the low and high inputs to check that the calibration was successful. You can press the Back button to return to a previous calibration stage to repeat it.

**SYS = 5.514293**

NOTE: Some instruments have parameters that clamp the output values. If the SYS output seems incorrect you should first check the instrument manual to see if there are any parameters that can clamp this output!

Step 4 of 4

Back    Finish    Cancel

The device is now calibrated. However you may find SYS has been 'clamped' if the resultant SYS is greater than SMAX or less than SMIN. If this is the case then change these values to suitable limits. In this example we may set SMIN to -0.5 (tonne) and SMAX to 12.0 (tonne). This would then provide clamping of SYS to these values and also a flags being set in FLAG and STAT.

## Sys Calibration Auto

Assume we require to calibrate for Kg output and we have available a known accurate 10 Kg and 100 Kg test weights.

Start the wizard by selecting Sys Calibration Auto from the Wizard menu

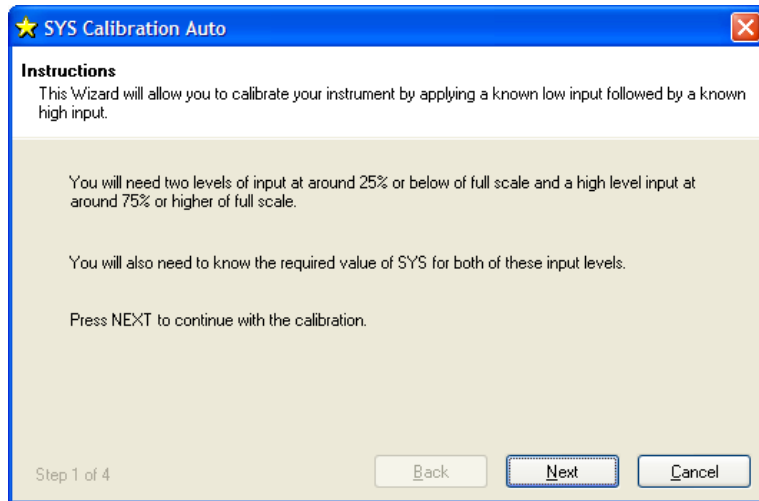

Click Next.

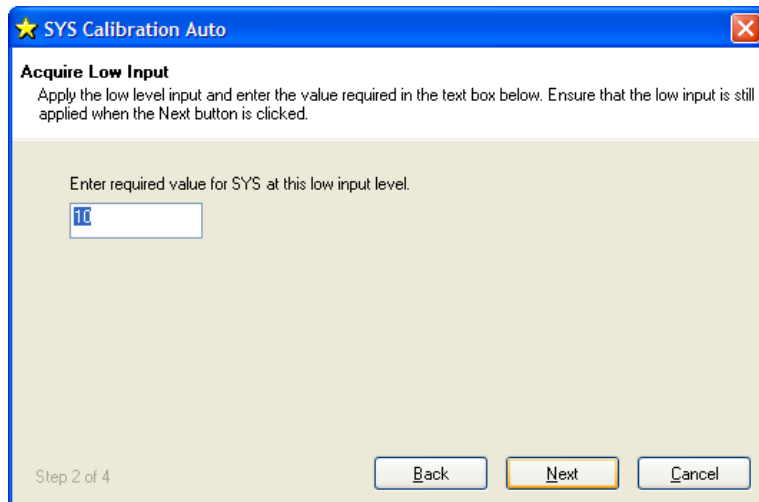

Apply the low known test weight and enter the required SYS value for this weight. In this case it will be 10 as we want the units of SYS to be Kg. Click Next to continue

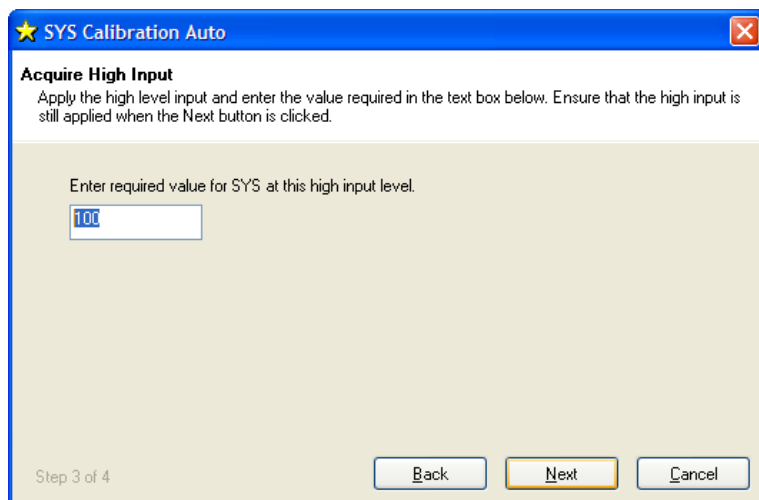

Apply the high known test weight and enter the required SYS value for this weight. In this case it will be 100. Click **Next** to continue.

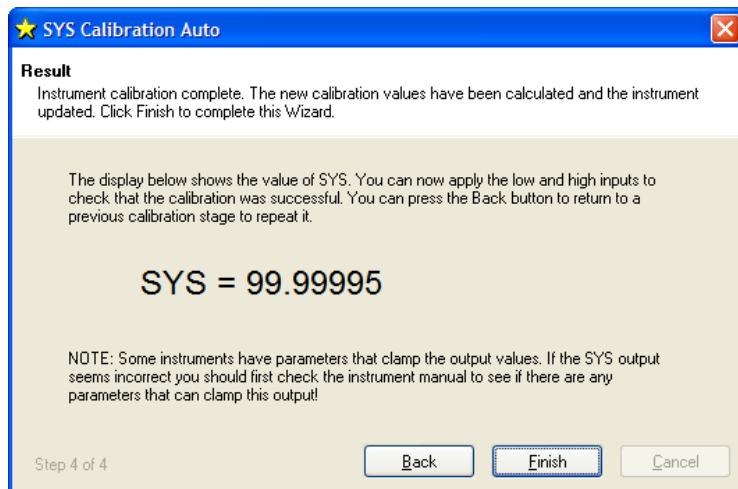

The device is now calibrated. However you may find SYS has been ‘clamped’ if the resultant SYS is greater than SMAX or less than SMIN. If this is the case then change these values to suitable limits. In this example we may set SMIN to -0.5 (Kg) and SMAX to 110.0 (Kg). This would then provide clamping of SYS to these values and also a flags being set in FLAG and STAT.

For detailed information about calibration calculations please refer to chapter 3.

## Chapter 3 Explanation of Category Items

Instrument Explorer shows the categories to which parameters and generated variables belong. This provides a convenient method for describing the functionality and purpose of each. The categories can be seen from Instrument Explorers Parameter List pane and are as follows.

### Information

Reports the current version of the devices software and the devices unique serial number. Note that VERSION is the read able item derived from the devices internal value of VER and SerialNumber is derived from SERL and SERH.

### Software Version, VER

The VER parameter (read-only byte) returns a value identifying the software release number, coded as  $256 * (\text{major-release}) + (\text{minor-release})$ , where MSB of VER is major release and LSB of VER is minor release

**Eg. current version 3.1 returns VER=769 (256 x 3 + 1)**

### Serial Number, SERL and SERH

SERL and SERH are read-only integer parameters returning the device serial-number.

This is decoded as  $= 65536 * \text{SERH} + \text{SERL}$ .

The VisualLink/Instrument Explorer software drivers include a convenience 'Serial Number' property that automatically does this.

### Strain Gauge

This is where the measurement process starts. If the optional temperature module is fitted then TEMP will display actual temperature in Degree C. Otherwise TEMP will display 125 Degree C.

RATE is the parameter that selects measurement cycle update rate.

### mV/V output, MVV

MVV is the factory calibrated mV/V output and it is this value that all other measurement output values are derived from. Factory calibration is within 0.05%.

### Nominal mV/V level, NMVV

This is used to represent the nominal mV/V value representing 100% of full scale. This value is used solely for the generation of ELEC. It is factory set for 2.5mV/V. If the electronic gain is adjusted by changing the gain resistor then if ELEC is used NMVV value must be changed to represent the new nominal mV/V.

### mV/V Output In Percentage Terms, ELEC

This is mainly for backwards compatibility with Version 2. It is the mV/V value represented in percentage terms, 100% being the value set by NMVV.

### Temperature Value, TEMP

If the optional temperature module is fitted, DTEMP then TEMP will display actual temperature in Degree C. Otherwise TEMP will display 125 Degree C. TEMP is used by the temperature compensation. See chapter 5

### Output Rate Control, RATE

The RATE parameter is used to select the output update rate, according to the following table of values -

RATE value	0	1	2	3	4	5	6	7	8
update rate (readings per second)	1	2	5	10	20	50	60	100	200

The default rate is 10Hz (RATE=3): The other settings give a different speed/accuracy trade-off. Invalid RATE values are treated as if it was set to 3.

The underlying analogue to digital conversion rate is 1627Khz. These results are block averaged to produce the required output rate.

**To Change The Output Rate**

1. Set **RATE** to the new value
2. Click on the '**RST**' button to reboot the device
3. Wait for one second for the reset procedure to complete and measure cycle to start

With **RATE** set to 0, you should be able to see the **SYS** update rate slow to once a second, and the noise level should also noticeably decrease.

All the main-reading output values are updated at this rate. Rate does not change the rate at which temperature output **TEMP** is updated.

**Important Note:**

For A **RATE** of 8 (200Hz) Temperature compensation and Linearisation cannot be used due to Calculation time required.

**Dynamic Filtering, FFST and FFLV**

The Dynamic filter is basically a recursive filter and therefore behaves like an “RC” circuit. It has two user settings, a level set in mV/V by **FFLV** and a maximum number of steps set by **FFST**, maximum value **FFST** can be is 255. If a difference between a new input value (**RMVV**) and the current filtered value (**MVV**) is greater than **FFLV** then the fractional amount of the new reading added to the current reading is reset to 1, that is to say that output of the filter will be equal to the new input reading. If the difference is less than **FFLV** then the fractional amount added is incremented until it reaches the maximum level set by **FFST**.IE if **FFST** = 10 then after a step change the fractional part of a new reading is incremented as follows

1/1, 1/2, 1/3, 1/4, 1/5, 1/6.... 1/10, 1/10, 1/10

This allows the Filter to respond rapidly to a fast moving input signal.

With a step change, which does not exceed **FFLV**, the calculated new filtered value can be calculated as follows

$$\text{New Filter Output value} = \text{Current Filter Output Value} + ((\text{Input Value} - \text{Current Filter Output Value}) / \text{FFST})$$

The time taken to reach 63% of a step change input (which is less than **FFLV**) is the frequency at which values are passed to the dynamic filter, set in **RATE**, multiplied by **FFST**.

The table below gives an indication of the response to a step input less than **FFLV**. Update Rate is 1/table value of **RATE** see Chapter 3 Output Rate Control.

% Of Final Value	Time To settle
63%	Update Rate * FFST
1%	Update Rate * FFST * 5
0.1%	Update Rate * FFST * 7

For example, If **RATE** is set to 7 = 100Hz = 0.01s and **FFST** is set to 30 then the time taken to reach a % of step change value is as follows.

% Of Final Value	Time To settle
63%	0.01 x 30 = 0.3 seconds
1%	0.01 x 30 x 5 = 1.5 seconds
0.1%	0.01 x 30 x 7 = 2.1 seconds

The following table shows the number of updates x **FFST** and the error % New Filter Output value will differ from a constant Input Value.

x FFST	% Error
1	36.7879441
2	13.5335283

3	4.97870684
4	1.83156389
5	0.67379470
6	0.24787522
7	0.09118820
8	0.03354626
9	0.01234098
10	0.00453999
11	0.00167017
12	0.00061442
13	0.00022603
14	0.00008315
15	0.00003059
16	0.00001125
17	0.00000414
18	0.00000152
19	0.00000056
20	0.00000021

Remember that if the step change in mV/V is greater than the value set in **FFLV** then **New Filter Output value = New Input Value**.

And the internal working value of **FFST** is reset to 1, being incremented each update set by **RATE** until it reaches the user set value of **FFST**.

## **Cell**

Provides the level where the integration between the DCell/DSC and the strain gauge bridge takes place. Features include, when the optional temperature module is fitted, 5-point temperature compensation to produce a temperature compensated value **CMVV**. Scaling using a gain and offset, **CGAI** and **COFS** respectively, producing a value known as **CRAW**. Linearisation, using up to 7-points, producing the final output from this section known as **CELL**. Over load and under load values can be set in **CMIN** & **CMAx** to alert the user of forces less or greater than the integrator has intended the unit to be operated. These features allow the output **CELL** to be in force units which can be used by 'System' to convert to units of weight.

Temperature compensation and linearisation are covered in detail in their own chapters.

### **Temperature Compensation In Brief**

When the optional temperature hardware module **DTEMP** is connected the temperature compensation is available. The temperature compensation facility can remove the need for the fitting of compensation resistors to the strain gauges. This compensation can apply for gain and offset with up to 5 temperature points.

The input for the temperature compensation is **MVV** and the output from the process is **CMVV**. If not temperature compensation is invoked the **CMVV** is equal to **MVV**

Temperature compensation cannot be used at **RATE** of 8 (200Hz)

A Detailed explanation is given in chapter 5

### **Cell Scaling, CGAI, COFS**

The temperature compensated value **CMVV** is scaled with gain and offset using **CGAI** and **COFS** respectively. The gain is applied first and the offset the subtracted. This would be used to give a force output in the chosen units, this output being termed **CRAW**.

$$\mathbf{CRAW} = (\mathbf{CMVV} \times \mathbf{CGAI}) - \mathbf{COFS}$$

## **Two Point Calibration Calculations and Examples**

Examples are given here for two point calibration, as this is by far the most common method.

Cell Calibration

The scaling parameters are **CGAI** and **COFS**

**CGAI** is in cell-units per mV/V'

**COFS** is in cell units

The cell output calculation is (in the absence of temperature and linearity corrections) -

$$\text{CRAW} = (\text{CMVV} \times \text{CGAI}) - \text{COFS}$$

If we have two electrical-output (**MVV**) readings for two known force loads, we can convert the output to the required range. So if -

$$\text{test load} = fA \rightarrow \text{CMVV reading} = cA$$

$$\text{test load} = fB \rightarrow \text{CMVV reading} = cB$$

- then calculate the following gain value

$$\text{CGAI} = (fB - fA) / (cB - cA)$$

and the offset is

$$\text{COFS} = (cA \times \text{CGAI}) - fA$$

The outputs should then be **CELL** = fA, fB true force values, as required.

### **Calibration Methods**

There are a number of ways of establishing the correct control values.

Method 1 - Nominal (data sheet) Performance Values

This is the simplest method, where the given nominal mV/V sensor output is used to calculate an approximate value for **CGAI**.

#### **Example.**

A 50 kN load cell has nominal sensitivity of 2.2mV/V full-scale.

So to get 50.0 for an input of 2.2mV/V, we set CGAI to  $50/2.2 \approx 22.7273$ . This assumes the output for 0kN is 0mV/V.

#### **Method 2 - Device Standard (Calibration) Values**

With some load cells you may have a manufacturer's calibration document. This gives precise cell-output gain and offset specifications for the individual cell. These values can be used to set the SGAI and SOFS values to be used.

#### **Example.**

A 10 tonne load cell has a calibration sheet specifying 2.19053mV/V full-scale output, and -0.01573mV/V output offset.

CGAI is set to  $10 / (2.19053 - -0.01573) \approx 4.532557$ .

COFS is set to  $-0.01573 \times 4.532557 \approx -0.0071297$

#### **NOTE:**

Methods 1 and 2 require no load tests. This means that systematic installation errors cannot be removed, such as cells not being mounted exactly vertical. The accuracy is also limited by the DCell/DSC electrical calibration accuracy, which is about 0.1%.

The remaining methods require testing with known loads, but are therefore inherently more reliable in practice, as they can remove unexpected complicating factors relating to installation.

#### **Method 3 - Two-Point Calibration Method**

This is a simple in-system calibration procedure, and probably the commonest method in practice (as in the previous example).

Two known loads are applied to the system, and reading results noted, then calibration parameters are set to provide exactly correct readings for these two conditions.

E.G. a 10kN (1-tonne) load cell has a CELL reading of +0.120721mV/V with no load, and -2.21854mV/V with a known 100Kg test-weight.

To calibrate this to read in a -1.0 to +1.0 tonne range,

Calculate CGAI as  $0.1 / (2.21854 - +0.120721) = 0.047669$ .

Set COFS=  $0.120721 \times 0.047669 = 0.005755$ .

#### Method 4 - Multi-point Calibration Test

For ultimate accuracy to a whole series of point measurements may be taken to determine the best linear scaling of input output: Effectively, a 'best line' through the data is then chosen, and the calibration is set up to follow the line.

Testing of this sort is also used to establish linearity corrections, and similar tests at different temperatures are used to set up temperature compensation (see Chapters on Temperature Compensation *and* Linearity Compensation).

**Note:** Instrument Explorer provides "wizards" for easy calibration of the Cell stage. There are two wizards, 'Cell Calibration Auto' and 'Cell Calibration Table' these can be found under the menu item "Wizards".

#### Cell Limits, CMIN, CMAX

These are used to indicate that the desired maximum and minimum value of CRAW have been exceeded. They are set in Force units. On CRAW being greater than the value set in CMAX the CRAWOR flag is set in both FLAG and STAT, the value of CRAW is also clamped to this value. On CRAW being less than the value set in CMIN the CRAWUR flag is set in both FLAG and STAT, the value of CRAW is also clamped to this value.

#### Linearisation In Brief

Linearisation allows for any non-linearity in the strain gauge measurement to be removed. Up to 7 points can be set using CLN. The principle of operation is that the table holds a value at which an offset is added. The point in the table that refer to CRAW are named CLX1..CLX7. The offsets added at these point are named CLK1.. CLK7 and are set in thousandths of a cell unit. The output from the Linearisation function is CELL. If no Linearisation is used (CLN < 2) the CELL is equal to CRAW.

Linearisation cannot be used at RATE of 8 (200Hz)

A Detailed explanation is given in chapter 6

#### System

System is where the "Force" output, CELL, is converted to weight when installed into a system. Other features such as SZ offers a means of zeroing the system output SYS. Peak and Trough values are also recorded against the value of SYS, these are volatile and reset on power up. A command SNAP records the next SYS value and stores in SYSN, this is useful where more than 1 device in a system and to prevent measurement skew across the system the SNAP command can be broadcast to all devices ready for polling of their individual SYSN values.

#### System Scaling, SGAI, SOFS

The cell output value CELL is scaled with gain and offset using SGAI and SOFS respectively. The gain is applied first and the offset the subtracted. This would be used to give a force output in the chosen units, this output being termed SRAW.

$$SRAW = (CELL \times SGAI) - SOFS$$

If we have two cell-output (CELL) readings for two known test loads, we can convert the output to the required range. So if -

Test load = xA → CELL reading = cA

Test load = xB → CELL reading = cB

Then we calculate the following gain value

$$SGAI = (xB - xA) / (cB - cA)$$

And then the offset

$$\text{SOFS} = (\text{cA} \times \text{SGAI}) - \text{xA}$$

The outputs should now be  $\text{SRAW} = \text{xA}, \text{xB}$  true load values, as required.

### ***Example of calculations for SGAI and SOFS***

**Example:**

A 2500Kgf load cell installation is to be calibrated by means of test weights.

The cell calibration gives an output in Kgf ranging 0-2000.

A system calibration is required to give an output reading in the range 0-1.0 tonnes.

#### **Calculations**

Take readings with two known applied loads, such as -

For test load of  $\text{xA} = 99.88\text{Kg}$  :      CELL reading  $\text{cA} = 100.0112$

For test load of  $\text{xB} = 500.07\text{Kg}$ :      CELL reading  $\text{cB} = 498.7735$

Calculate gain value. In this case put  $\text{SGAI} = (\text{xB} - \text{xA}) / (\text{cB} - \text{cA})$

$$= (0.50007 - 0.09988) / (498.7735 - 100.0112)$$

$$\approx 0.001003580 = 1.003580 \times 10^{-3}$$

Calculate offset value. In this case  $\text{SOFS} = (\text{cA} \times \text{SGAI}) - \text{xA}$

$$= (100.0112 \times 1.003580 \times 10^{-3}) - 0.09988$$

$$\approx 0.00048924$$

**Check**

Putting the values back into the equation, results for the two test loads should then be –

For  $\text{x} = 99.88\text{Kg}$ , CELL = 100.0112, so

$$\text{SRAW} \approx (100.0112 \times 1.003580 \times 10^{-3}) - 0.00048924 \approx 0.09988$$

For  $\text{x} = 500.07\text{Kg}$ , CELL = 498.7735, so

$$\text{SRAW} \approx (498.7735 \times 1.003580 \times 10^{-3}) - 0.00048924 \approx 0.5006987$$

The remaining errors are due to rounding the parameters to 7 figures.

Internal parameter storage is only accurate to about 7 figures, so errors of about this size can be expected in practice.

### ***System Limits, SMIN, SMAX***

These are used to indicate that the desired maximum and minimum value of **SRAW** have been exceeded. They are set in weight units. On **SRAW** being greater than the value set in **SMAX** the **SRAWOR** flag is set in both **FLAG** and **STAT**, the value of **SRAW** is also clamped to this value. On **SRAW** being less than the value set in **SMIN** the **SRAWUR** flag is set in both **FLAG** and **STAT**, the value of **SRAW** is also clamped to this value.

## ***System Zero, SZ***

SZ provides a means of applying a zero to SYS and SOUT. This could be used to generate an Net value making SRAW in effect a gross value.

$$\text{SYS} = \text{SRAW} - \text{SZ}$$

Care should be taken on how often SZ is written to, see “WARNING: Finite Non-Volatile Memory Life” later in this chapter.

## ***System Outputs, SYS, SOUT***

SYS is considered to be the main output value and it is this value that would be mainly used by the master. SOUT is for backwards compatibility with Version 2

## ***Reading Snapshot, SNAP, SYSN***

The action command SNAP samples the selected output by copying SYS to the special result parameter SYSN.

The main use of this is where a number of different inputs need to be sampled at the same instant.

Normally, multiple readings are staggered in time because of the need to read back results from separate devices in sequence: The snap is always carried out on receipt of a valid sync ID . The resulting values can then be read back in the normal way from all the devices SYSN parameters.

Note: Instrument Explorer provides “wizards” for easy calibration of the System stage. There are two wizards, ‘Sys Calibration Auto’ and ‘Sys Calibration Table’ these can be found under the menu item “Wizards”.

## ***Control***

### ***Shunt Calibration Commands, SCON and SCOF***

The Device is fitted with a “Shunt” calibration resistor whose value is 100K. This can be switched across the bridge, using SCON, giving an approximate change of 0.8mV/V at nominal 2.5mV/V. The command SCOF removes the resistor from across the bridge. It is important for the user to remember to switch out the shunt calibration resistor after calibration has been confirmed.

### ***Digital Output, OPON and OPOF***

For DSC ONLY an open collector output is available. This can be switched on using OPON and off by the command OPOF. This output is capable of switching 100mA at 30v (TBC)

## ***Flags***

### ***Diagnostics Flags, FLAG and STAT***

All the self-diagnostics rely on the FLAG & STAT parameters, which are 16-bit integer register in which different bits of the value represent different diagnostic warnings. FLAG is stored in EEPROM and is therefore non-volatile, STAT is stored in RAM and reset on power-up to 0. FLAG is latching requiring reset by the user where as STAT is non-latching showing current error status.

### ***Latched Warning Flags (FLAG)***

The flags are normally used as follows:-

FLAG is read at regular intervals by the host (like the main output value, but generally at longer intervals)

If some warnings are active, i.e. FLAG is non-zero, then the host tries to cancel the warnings found by writing FLAG= 0

The host then notes whether the error then either remains (i.e. couldn't be cancelled), or if it disappears, or if it re-occurs within a short time, and will take action accordingly.

The warning flags are generally latched indicators of transient error events: By resetting the register, the host both signals that it has seen the warning, and readies the system to detect any re-occurrence (i.e. it resets the latch).

What the host should actually do with warnings depends on the type and the application: Sometimes a complete log is kept, sometimes no checking at all is needed.

Often, some warnings can be ignored unless they recur within a short time.

Warning flags survive power-down, i.e. they are backed up in non-volatile (EEPROM) storage.

Though useful, this means that repeatedly cancelling errors which then shortly recur can wear out the device non-volatile storage - see Chapter 3 Basic Set-up and Calibration.

### **Meaning and Operation of Flags**

The various bits in the FLAG value are as follows

Bit	Value	Description	Name
0	1	(unused - reserved)	Unused
1	2	(unused - reserved)	Unused
2	4	Temperature under range ( TEMP)	TEMPUR
3	8	Temperature over-range (TEMP)	TEMPOR
4	16	Strain gauge input under-range	ECOMUR
5	32	Strain gauge input over-range	ECOMOR
6	64	Cell under-range (CRAW)	CRAWUR
7	128	Cell over-range (CRAW)	CRAWOR
8	256	System under-range (SRAW)	SYSUR
9	512	System over-range (SRAW)	SYSOR
10	1024	(unused - reserved)	Unused
11	2048	Load Cell Integrity Error (LCINTEG)	LCINTEG
12	4096	Watchdog Reset	WDRST
11	8192	(unused - reserved)	Unused
14	16384	Brown-Out Reset	BRWNOUT
15	32768	Reboot warning (Normal Power up)	REBOOT

#### **NOTE:**

The mnemonic names are used by convenience properties in Instrument Explorer, but are otherwise for reference only -the flags can only be accessed via the FLAG parameter.

**The various warning flags have the following meanings**

**TEMPUR and TEMPOR** indicate temperature under-and over-range. The temperature minimum and maximum settings are part of the temperature calibration, fixed at -50.0 and +90.0 °C. Only active when optional Temperature module fitted.

**ECOMUR and ECOMOR** are the basic electrical output range warnings. These are tripped when the electrical reading goes outside fixed  $\pm 120\%$  limits: This indicates a possible overload of the input circuitry, i.e. the input is too big to measure.

The tested value, ECOM is an un-filtered precursor of ELEC

**CRAWUR and CRAWOR** are the cell output range warnings. These are tripped when the cell value goes outside programmable limits CMIN or CMAX.

The tested value, CRAW is the cell output prior to linearity compensation.

**SYSUR and SYSOR** are the system output range warnings. These are triggered if the SYS value goes outside the SMIN or SMAX limits.

**LCINTEG** indicates a missing or a problem with the Load cell. It is based on the common mode of the -SIG being correct. NOTE This flag will also be set when the shunt calibration has been switched on.

**WDRST** indicates that the Watchdog has caused the device to re-boot. If this error continually occurs consult factory.

**BRWNOUT** indicates that the device has re-booted due to the supply voltage falling below 4.1V, the minimum spec for supply voltage is 5.6V and this must include any troughs in the AC element of this supply.

**REBOOT** is set whenever the DCell/DSC is powered up and is normal for a power up condition. This flag can be used to warn of power loss to device.

### **Dynamic Status Flags (STAT)**

Status are “live” flags, indicating current status of the device. Some of these flags have the same bit value & description from “FLAG”.

### **Meaning and Operation of Flags**

The various bits in the STAT value are as follows

Bit	Value	Description	Name
0	1	Setpoint output status	SPSTAT
1	2	Digital Input status (DSC ONLY)	IPSTAT
2	4	Temperature under range (TEMP)	TEMPUR
3	8	Temperature over-range (TEMP)	TEMPOR
4	16	Strain gauge input under-range	ECOMUR
5	32	Strain gauge input over-range	ECOMOR
6	64	Cell under-range (CRAW)	CRAWUR
7	128	Cell over-range (CRAW)	CRAWOR
8	256	System under-range (SRAW)	SYSUR
9	512	System over-range (SRAW)	SYSOR
10	1024	(unused - reserved)	Unused
11	2048	Load Cell Integrity Error (LCINTEG)	LCINTEG
12	4096	Shunt Calibration Resistor ON	SCALON
11	8192	Stale output value (previously read)	OLDVAL
14	16384	(unused - reserved)	Unused
15	32768	(unused - reserved)	Unused

**SPSTAT** indicates the state of the Open collector output, 1 being output on 0 being output off.

**IPSTAT** indicates the state of the digital input (Only available on DSC model). Bit set indicates input is ‘closed’ to 0v (-V or GND).

**SCALON** Used to indicate that the Shunt Calibration command, **SCON**, has been issued & therefore the shuntcal resistor is now in circuit with the strain gauge bridge. **SCOF** command resets this bit. Note that when Shunt Calibration is active the “Load Cell Integrity Error” will also be generated.

**OLDVAL** is set when the device is read via the communications. Thus indicating this value has already been sampled. It is reset when a new result has been made available.

### **Output Update Tracking**

The **OLDVAL** flag can be used for output update tracking

This allows sampling each result exactly once: To achieve this poll the **STAT** value until **OLDVAL** is cleared to indicate a new output is ready, then read **SYS**, this reading will set the **OLDVAL** flag in **STAT**.

This scheme works as long as the communications speed is fast enough to keep up. With faster update rates and slower baud rates, it may not be possible to read out the data fast enough.

## ***User Storage***

### ***USR1...USR9***

There are nine storage locations **USR1** to **USR9**. These are floating point numbers which can be used for storage of data. This data could be calibration time and date, operator number, customer number etc. This data is not used in anyway by the DCell or DSC.

## ***Reset***

### ***The Reset command, RST***

This command is used to reset the device. This command **MUST** be issued if the following parameters are changed before the change will take effect. Alternatively the power maybe cycled.

**RATE, NODEIDL, NODEIDH, BPS and all of the Message parameters**

The reset action may take up to about a second to take effect, followed by the normal start-up pause of 1 second.

### ***WARNING: Finite Non-Volatile Memory Life***

The DCell and DSC use EEPROM-type memory as the storage for non-volatile controls (i.e. all the settings that are retained even when powered down).

The device EEPROM itself is specified for 100,000 write cycles (for any one storage location), although typically this is 1,000,000. Therefore -

When automatic procedures may write to stored control parameters, it is important to make sure this does not happen too frequently.

So you should not, for example, *on a regular basis* adjust an offset calibration parameter to zero the output value. However, it *is* reasonable to use this if the zeroing process is initiated by the operator, and won't normally be used repeatedly.

For the same reason, automatically cancelling warning flags must also be implemented with caution: It is okay as long as you are not getting an error recurring *repeatedly*, and resetting it every few seconds.

## Chapter 4 The Readings Process

This chapter gives an account of the reading process *except* for the linearity-and temperature-compensation processes (which have their own chapters later on).

### Flow diagram

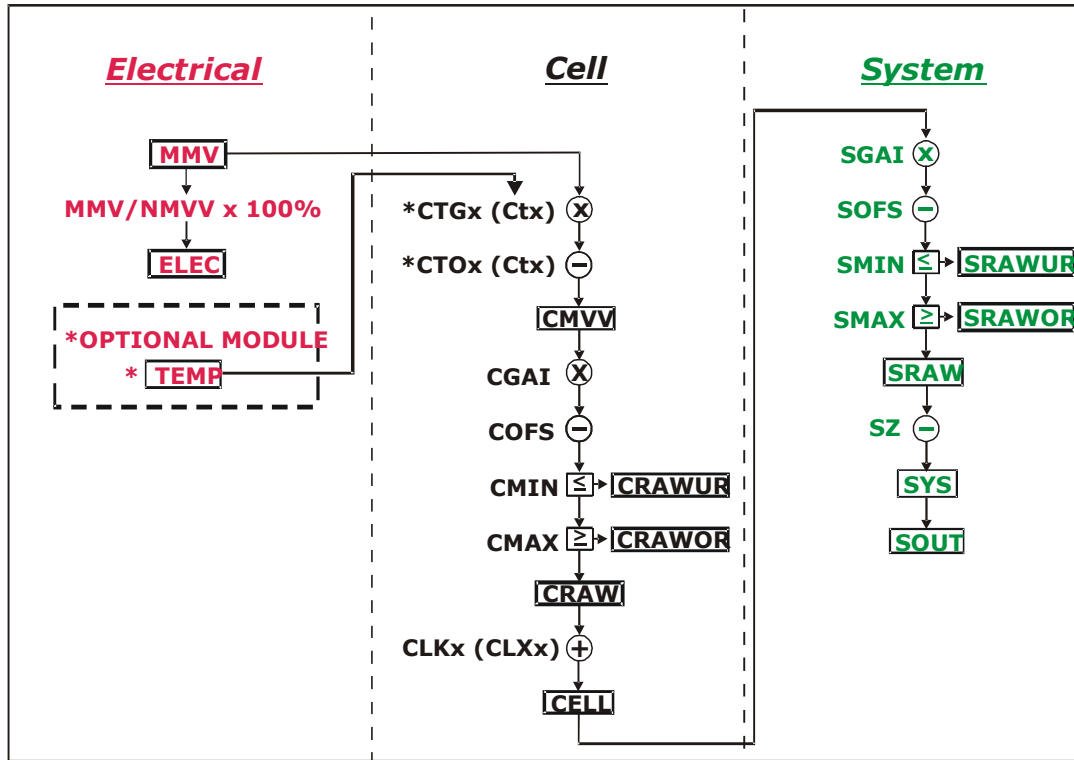

The underlying analogue to digital conversion rate is 3.255Khz. These results are block averaged to produce the required output rate set by the **RATE** control This block averaged result is then passed through the dynamic filter at the same rate and then into the 'chain' of above calculations.

The named values shown in the boxes are all output parameters, which can be read back over the comms link. The diagram shows *three separate calibration stages*, called the 'Electrical', 'Cell' and 'System'. This allows independent calibrations to be stored for the device itself, the load cell and the installed system characteristics -

#### Electrical

The 'Electrical' calibration produces corrected electrical readings from the internal measurements. This is factory-set by Mantracourt during the production process.

The main outputs from this are -

- **MMV** is the factory calibrated output, in mV/V units.
- **ELEC** is the mV/V in % terms. Where the 100% value is set using **NMMV**. This is for backwards compatibility only.
- **TEMP** is a device temperature measurement, in °C and requires an optional module.

There are also two flags, **ECOMUR** and **ECOMOR** (not shown on the diagram), which indicate an input electrical under- or over-range.

#### Cell

The 'Cell' calibration converts the mV/V output into a cell-force reading.

This can be used by an OEM sensor manufacturer to provide a standard, calibrated output in force units, which could be based on either typical or device-specific calibration data.

(This stage also includes the temperature- and linearity-corrections, not covered here)

The outputs from this are

- **CMVV** is the temperature compensated mV/V (**MVV**).
- **CRAW** is the scaled temperature compensated value **CMVV**
- **CELL** is a load cell force reading in “Force” units (e.g. kN)
- **CRAWUR** and **CRAWOR** are two flags indicating under or, over range for the force measurement.

### System

The ‘System’ calibration converts the Cell output into a final output value, in the required engineering units. This is normally be set up by a systems installer or end user, to provide whatever kind of output is needed, independently of device-specific information in the Cell calibration.

(Making this split allows in-service replacement without re calibration).

The Outputs From This Are

- **SRAW** is a re-scaled and offset adjusted output derived from **CELL**
- **SYS** is the final output value, after removing a final user output offset value (**SZ**) from **SRAW**
- **SRAWUR** and **SRAWOR** are output warning limit flags.

In practice, **SRAW** and **SYS** can be used to represent something like gross and net values.

## Cell and System Scaling

Both the Cell and System calibrations are simply linear rescaling calculations -i.e. they apply a gain and offset.

In both cases, four parameters define the scaling, offset and min and max limit values. These calculations are applied in the following way:

Output = (Input × **GAI**) - **OFS**

Output = min (output, **MAX**)

Output = max (output, **MIN**)

(In addition, if the value exceeds either limit, one of two dedicated error flags is set)

The control parameters thus have the following characteristics: -

- **GAI** is the multiplying factor, set in “output-units per input-unit”
- **OFS** is the value that gives zero output, set in “output units”
- **MAX** and **MIN** are output limit values, set in “output units”

The units and functions of the main scaling controls can thus be summarised as -

#### Cell Calibration

<b>CGAI</b>	Force/mV/V	mV/V gain factor
<b>COFS</b>	Force	<b>CELL</b> Offset Value
<b>CMIN</b>	Force	Minimum value for <b>CRAW</b>
<b>CMAX</b>	Force	Maximum value for <b>CRAW</b>

#### System Calibration

<b>SGAI</b>	Eng/ Force	<b>SYS/CELL</b> gain factor
<b>SOFS</b>	Eng	<b>SRAW</b> value offset
<b>SMIN</b>	Eng	Minimum value for <b>SRAW</b>
<b>SMAX</b>	Eng	Maximum value for <b>SRAW</b>
<b>SZ</b>	Eng	<b>SYS</b> value offset

(**MVV** is mV/V, “force” is force units, and “eng” is engineering units)

## Calibration Parameters Summary and Defaults

The various control parameters are listed for each stage.

This also includes the compensation parameters, not covered in this chapter, but shown in the flow diagram

The 'default' values shown set the device back to its nominal default calibration (mV/V)

### Cell Control Defaults

Command	Action	Default Values
FFLV	Filter dynamic level	0.001
FFST	Filter Steps (max)	100
NMMV	Nominal 2.5mV/V	2.5
RATE	Rate 10Hz	3
CGAI	basic cell gain	1.0
COFS	basic cell offset	0.0
CTN	number of temp points	0
CT1..5	temp points (Deg C)	0.0, 0.0, 0,0...
CTO1..5	offset adjusts	0.0, 0.0, 0,0...
CTG1..5	gain adjusts	1.0, 1.0, 1.0, 1.0...
CMIN	<b>CRAW</b> min limit	-3.0
CMAX	<b>CRAW</b> max limit	+3.0
CLN	number of linearity points	0
CLX1..7	linearity raw-value points	0.0, 0.0, 0,0...
CLK1..7	linearity adjusts	0.0, 0.0, 0,0...

### System Control Defaults

Command	Action	Default Values
SGAI	basic gain	1.0
SOFS	basic offset	0.0
SMIN	<b>SRAW</b> min limit	-100.0
SMAX	<b>SRAW</b> max limit	+100.0
SZ	output zero offset	0.0

## Chapter 5 Temperature Compensation

This chapter explains how to use the Temperature Compensation facilities, to compensate for changes in the measurement with ambient temperature.

Temperature compensation is only provided when an optional module consisting of a digital temperature sensor is wired to the DCell or DSC.

### **Purpose and Method of Temperature Compensation**

Most measurement methods are affected by changes in temperature, and (uncompensated) load cells are especially sensitive, having a large overall temperature coefficient.

Temperature compensation adjusts the measured value in a way that depends on a temperature measurement, so that (ideally) the output does not depend on the current temperature.

In practice, it is usual to refer to a calibration 'reference' temperature: The ideal output value is then what the reading 'would have been' if made at the reference temperature.

The DCell/DSC temperature compensation facilities make adjustments to the 'Cell' calibration parameters (i.e. gain and offset) which depend on temperature, according to a digitally programmed curve.

These adjustments are automatically applied, based on the current device temperature measurement. With some care, this can remove the need for the usual electrical compensation components altogether.

Note that the temperature compensation will also remove the temperature drift of the DCell/DSC itself if the temperature compensation data is collected when the DCell/DSC and strain gauges are tested together as a system.

### **Temperature Module Connections and Mounting (DTEMP)**

The temperature module is connected using only two wires. The temperature sensor is the Dallas "1-Wire" digital device DS18S20. One connection is ground for which -EXC is used and the other is the 1 wire "DQ" connection which provides the bi-directional data line.

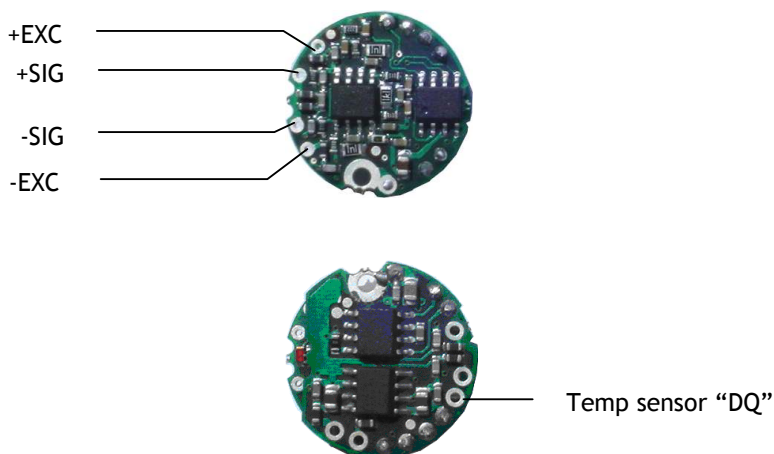

Note: -EXC provides the ground connection to the optional temperature module.

For DSC the DQ connection is connected to the I/O pin marked TS.

The temperature module is a small double sided PCB with an 8 pin SOIC integrated circuit mounted to it. The dimensions are 10.5 x 7.6 x 2.5mm. There are two solder pads for connection to the DSC or DCell. A 2mm hole is used for fixing the temperature module to the body of the load cell. The module should, ideally, be positioned as

close as possible to the strain gauges. The IC on the temperature module must also be in good thermal contact to the load cell body so the strain gauges and temperature sensor see the same temperature.

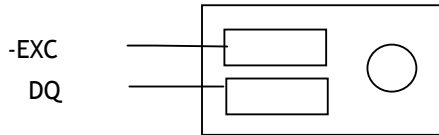

### Control Parameters

The temperature compensation parameters define a pair of lookup tables that contain adjustments to the cell calibration gain and offset over temperature.

The parameters concerned are the following

CTN	[-]	Number of temperature table points
CT1...CT5	[°C]	Indicated TEMP value at table point
CTO1...CTO5	mV/V	MV/V ( $\times 10^4$ ) Offset adjustment at Offset table point
CTG1...CTG5	ppm	Gain ( $\times 10^6$ ) at Gain table point

**CTN** sets the number of points in the gain & offset table's. A **CTN** value of less than two effectively switches off temperature compensation. The maximum number of point is 5, values greater than 5 reset **CTN** to 0 switching off temperature compensation.

**CT1** to **CT5** sets the temperature in degree C of the correction points. The table must be filled from **CT1** up to & including **CT(CTN)** and must be entered in order of increasing temperature value.

**CTO1** to **CTO5** provide the offset adjustment in  $mV/V \times 10^4$ . The reason for the multiplication is due to the limitation set by the ASCII protocol of only being able to enter up to 6 decimal places. The **CTOx** value is **subtracted** from the uncompensated value.

**CTG1** to **CTG5** provide the gain adjustment in ppm terms.  
The actual gain value used is calculated as  $1 + CTGn \times 10^{-6}$ .

### Internal Calculation

The temperature compensation calculation is described as follows:-

The GAIN correction is applied first. The current measured temperature is checked against the table values CT1 to CT(CTN) to establish an index value if the measured temperature is below that of CT1 then CT1 is used as the index, If the temperature is above CT(CTN-1) then CT(CTN-1) is used.

This can be represented as follows:-

A working table index, *i*, is derived from the current measured temperature, *T*, as follows –

(*n* = number of points used, as set by CTN)

When (*T* < CT1) then *i* = 1

When (*T* > CT*n*-1) then *i* = (*n*-1)

Otherwise *i* is chosen so that  $T_i \leq T \leq T_{i+1}$

Once an index into the table has been established the gain value to be used is extrapolated between the index value and the value above. If the temperature is above CT(CTN) or below CT1 then the calculated temperature gain value is extrapolated from CT(CTN-1) to CT(CTN) or CT1 to CT2 respectively.

This can be represented mathematically as follows:-

$$CALC\_CTG = CTG_i + (CTG_{i+1} - CTG_i) \times (T - CT_i) / (CT_{i+1} - CT_i)$$

The actual gain value used is  $1 + CALC\_CTGO \times 10^{-6}$  and is multiplied by the uncompensated value *MVV*.

The offset correction is then applied. Using the same temperature index “*i*” as found for the GAIN index above.

The Offset value is extrapolated between the same two temperature points.

This can be represented mathematically as follows:-

$$\text{CALC\_CTO} = \text{CTO}_i + (\text{CTO}_{i+1} - \text{CTO}_i) \times (T - \text{CT}_i) / (\text{CT}_{i+1} - \text{CT}_i)$$

The actual offset value used is  $\text{CALC\_CTO} \times 10^{-4}$  and is subtracted from the above gain adjusted value.

The output from the temperature compensation (CMVV) is then calculated as

$$\text{CMVV} = \text{MVV} \times (1 + \text{CALC\_CTGO} \times 10^{-6}) - (\text{CALC\_CTO} \times 10^{-4})$$

## ***The Temperature Measurement***

The temperature sensor used is a Dallas (MAXIM) DS18S20 Digital Thermometer using the “1-Wire” bus technology. This gives a temperature measurement accuracy of +/-0.5 Degree C over the temperature range -10 to +85 degree C and +/-2.0 Degree C over temp range -55 to +125 Degree C. The resolution of the measurement is 0.0625 Degree C. The temperature is sampled and the **TEMP** variable updated every 5 seconds.

## ***How to Set Up a Temperature Compensation***

There are a number of ways of obtaining a temperature compensation curve.

The best possible compensation for a given piece of physical hardware can only be achieved by performing experiments on that particular unit (DCell/DSC and associated strain gauges), to characterise the measurement output at a variety of different, stable temperatures in the required operating range.

The basic choice of methods depends on trading off ideal accuracy against the complexity of the calibration procedure.

### **Method 1**

Apply a simple linear drift correction (i.e. for known constant gain and offset changes per degree), by specifying zero correction at the calibration temperature, and appropriately adjusted correction values at extreme temperatures above and below this.

This can be used when the measurement or sensor has known temperature coefficients.

### **Method 2**

Where the temperature characteristics of the measurement are known, but not linear, a similar scheme to Method 1 can be used, with a multi-point table defining an approximation to the known, ideal temperature curves of offset and gain variations.

**NOTE:** Both of the above methods are based on ‘known’ characteristics, which could come from datasheets but these methods would not compensate for the DCell/DSC.

### **Method 3**

Do a series of measurements at different temperatures and install the appropriate correction values to give exactly correct results at those same temperatures -i.e. calculate ideal gain and offset corrections at the tested temperatures.

*(This method is the most common).* There is a ‘wizard’ available in Instrument Explorer which will enable this method to be easily completed by calculating the gain and offset corrections for you.

### **Method 4**

Use a set of test results to plan a ‘best correction’ curve (not necessarily perfect at test temperatures, but slightly better overall).

### **NOTES:**

All of these methods can be applied *either* to data from individual devices *or* to an ‘average’ correction for a particular type of sensor hardware.

During testing, temperatures should be measured using the internal TEMP measurement, as this is the measurement used to do the corrections.

For in-system tests, the environment of the DCell/DSC must always be as near as possible to the exact conditions of the eventual in-system use.

## ***Parameter Calculations***

Instrument Explorer provides a “Wizard” for the calculation of the parameters required by the DSC/DCell. This is based on Method 3 where data is collected. The wizard allows for small changes in the sampled temperature point that may occur when taking a set of results for gain and offset. Also taken into account is any variation in the test weights at different temperatures. This is a complex mathematical procedure which is best solved by a PC programme such as the wizard.

## Chapter 6 Linearity Compensation

This chapter describes the Linearity Compensation features and how to use them.

### Purpose and Method of Linearisation

Load cell sensor outputs are never precisely proportional to the input (applied load).

If the graph of the measurement output against the true value shows slight deviations from the ideal straight-line, then slight errors remain even when the basic calibration (offset and gain) is as good as possible.

Linearity compensation adjusts the raw measurement by a small amount that is calculated as a function of the raw measurement value itself. Ideally this will adjust the output response, for any given input load, by exactly the right amount to place the final result onto the ideal straight line.

The DCell/DSC non-linearity compensation uses a single 'lookup table', similar to those used for temperature compensation (see previous chapter). This provides a linearly-interpolated compensating value with up to 7 control points, which is then added to the output result.

Generally, linearisation is a finer level of compensation than temperature compensation.

It should only be applied after the basic Cell calibration and temperature compensation (if any) have been set up. Although the tests are generally simpler than testing over temperature, the accuracy requirement is often greater. See below for notes of possible difficulties to be avoided.

### Control Parameters

Refer to the table in Chapter 9 for command numbers

The lookup table (based on parameters **CLXi**, **CLKi**) defines an offset adjustment based on the **CRAW** value, which is then added in to give the final **CELL** output.

(So linearity correction is applied after any temperature compensation.)

#### The Parameters Involved Are :

<b>CLN</b>	Sets the number of linearisation points (from 2 up to 7)
<b>CLX1..7</b>	Raw input ( <b>CRAW</b> ) value points
<b>CLK1..7</b>	Output ( <b>CELL</b> ) adjustments to apply at these points

#### They are used like this :

- The number of calibration points is set by CLN (from 2 up to 7)
- Raw input value points are set by CLX1, CLX2 .. CLX7 (or up to the number set by CLN)  
These *must* be arranged in order of increasing input value.
- The output corrections at these points are set by CLK1, CLK2 .. CLK7
- **Corrections are specified in "thousandths of a cell unit"**. So a CLKi of 1.0 actually adds 0.001 to the CELL output). This due to a limitation in the ASCII conversion to floating point numbers.

### Internal Calculation

This uses the same basic 'interpolated table lookup' method as for temperature compensation.

First, a working table index, *i*, is derived from the current raw input **CRAW**=*x*, as follows :

(*n* = number of points used, as set by CLN)

When (*x* < CLX<sub>1</sub>)      then *i* = 1

When (*x* > CLX<sub>*n*-1</sub>)      then *i* = (*n*-1)

Otherwise      *i* is chosen so that CLX<sub>*i*</sub> ≤ *x* ≤ CLX<sub>*i*+1</sub>

The resulting interpolated adjustment value is then calculated as -

$$\text{ofs} = \text{CLK}_i + (\text{CLK}_{i+1} - \text{CLK}_i) \times (x - \text{CLX}_i) / (\text{CLX}_{i+1} - \text{CLX}_i)$$

Then the compensated cell value is calculated as -

$$\text{CELL} = \text{CRAW} + \text{ofs}$$

## How to Set Up Linearity Compensation

A linearity correction can be set up either from sensor specification/calibration data, or more commonly from in-system testing results.

Assuming we do not have any prior information on linearity errors, the usual approach is to do a series of controlled tests with accurately known test loads.

Just as with temperature compensation, it is *possible* to obtain a detailed graph of linearity error and then choose a 'best-fit' piecewise linear curve for the compensation table.

However, it is generally good enough, and much simpler, to simply test at several different points and then apply an exact correction at those points. If the error curve is reasonably smooth, this should give exact results at the test points, and reasonably accurate values in between.

### NOTES:

Linearisation tests should only be done *after* the cell calibration is set, because the correction values are dependent on the cell calibration.

Similarly, linearisation testing should only be done at the calibration 'reference' temperature, or after temperature compensation is installed, to avoid temperature effects from distorting the results.

The linearisation tests should not reveal any significant remaining linear trend in the errors.

If errors do appear to lie on a definite line, this could drastically reduce the accuracy of the correction.

If this does happen, it shows that the cell calibration is wrong and should be redone.

The table points must always cover more-or-less the whole range of output values to be used, because corrections are extrapolated outward beyond the first and last points.

It is always worthwhile including more test-points than will be used in the correction table, because this gives confidence that no regions of rapidly changing error have been missed.

Tests should be done both with steadily increasing *and* decreasing load values, as hysteresis effects (for load cells) are often of a similar size to non-linearities.

## Parameter Calculations and Example

Based on the simple method outlined above, we suppose that we have obtained test results for a series of precisely known load values -

test loads  $X_i$  give readings of CRAW =  $C_i$ , for ( $i = 1..n$ )

Then calculate the errors that need to be removed at these points -

$$E_i = X_i - C_i$$

Now just enter these values into the correction table, remembering to scale the errors -

$$CLN = n$$

$$CLX_i = X_i$$

$$CLK_i = 1000 \cdot E_i$$

### Example

Suppose we have a load cell and Cell calibration giving a result in the range 0-500 KgF.

The following test results were obtained using a series of known test loads -

For test load of  $x_1 = 0\text{Kg}$  : CELL reading  $c_1 = 0.0010$

For test load of  $x_2 = 100.13\text{Kg}$  : CELL reading  $c_2 = 100.44$

For test load of  $x_3 = 199.72\text{Kg}$  : CELL reading  $c_3 = 200.57$

For test load of  $x_4 = 349.97\text{Kg}$  : CELL reading  $c_4 = 349.75$

For test load of  $x_5 = 450.03\text{Kg}$  : CELL reading  $c_5 = 449.98$

We choose these precise test points as our linearisation reference points, so

$$CLN = 5$$

$$CLX_1 = 0.0010$$

$$CLX_2 = 100.44$$

CLX3 = 200.57

CLX4 = 349.75

CLX5 = 449.98

(Note that these are the raw reading values, not the known true values.)

Now calculate all the residual errors, and set up the correction factors -

$$CLK1 = 10^3 \times (x1 - c1) \approx 1000 \times (000.00 - 0.0010) = -1.0$$

$$CLK2 = 10^3 \times (x2 - c2) \approx 1000 \times (100.13 - 100.44) = -310.0$$

$$CLK3 = 10^3 \times (x3 - c3) \approx 1000 \times (199.72 - 200.57) = -850.0$$

$$CLK4 = 10^3 \times (x4 - c4) \approx 1000 \times (349.97 - 349.75) = +220.0$$

$$CLK5 = 10^3 \times (x5 - c5) \approx 1000 \times (450.03 - 449.98) = +320.0$$

The CELL output values will now have the required values at all these 5 points.

#### Note on the Example

If you graph the errors from the above example, the results look like this

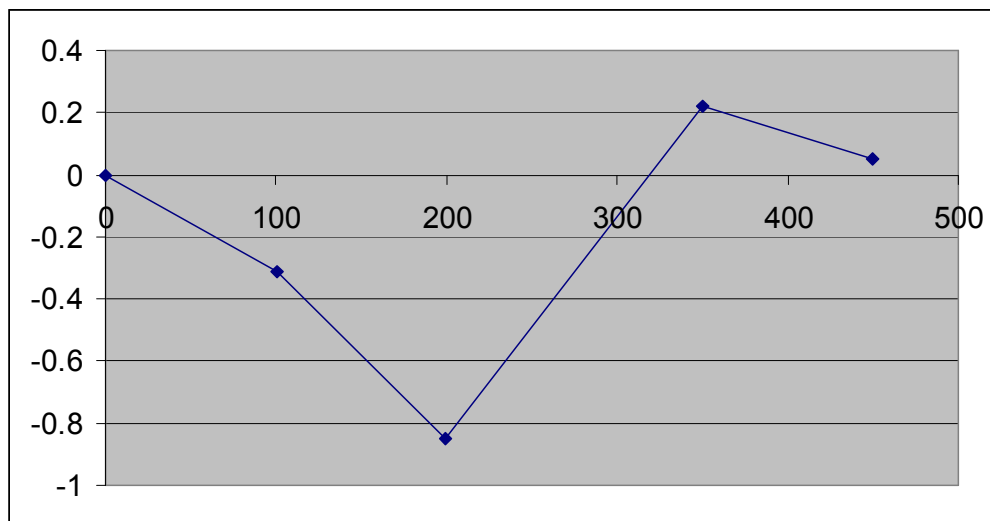

This doesn't show any very definite linear trend, so the calibration is okay.

However there *is* a big jump between points 3 and 4, which might be worth a more detailed investigation: Some important features of the error curve could have been missed by the test.

## Chapter 7 Self-Diagnostics

### Diagnostics Flags

The main diagnostics facilities are by means of the flags. See chapter 3 Flags for a full description of the flags and their meaning.

The flags are normally used something like this.

**FLAG** is read at regular intervals by the host (like the main output value, but generally at longer intervals)

If some warnings are active, i.e. **FLAG** is non-zero, then the host tries to cancel the warnings found by writing **FLAG= 0**

The host then notes whether the error then either remains (i.e. couldn't be cancelled), or if it disappears, or if it re-occurs within a short time, and will take action accordingly.

The warning flags are latched indicators of transient error events: By resetting the register, the host both signals that it has seen the warning, and readies the system to detect any re-occurrence (i.e. it resets the latch).

What the host should actually do with warnings depends on the type and the application: Sometimes a complete log is kept, sometimes no checking at all is needed.

Often, some warnings can be ignored unless they recur within a short time.

Warning flags survive power-down, i.e. they are backed up in non-volatile (EEPROM) storage.

Though useful, this means that repeatedly cancelling errors which then shortly recur can wear out the device non-volatile storage - see *WARNING: Finite Non-Volatile Memory Life* in chapter 3.

**STAT** provides a current status of the device. These flags are not latched and not saved on power fail.

### Diagnostics LED

A new feature for Version 3 is the addition of an LED to indicate the current status of the device. If all is healthy the LED should flash ON for a period of 100mS , The rate at which the LED flashes is 0.5 second.

If an error conditions occurs which is based on any of the following error flags being set then the operation of the LED will invert. IE the LED will flash off for 100mS at the rate set in the table above.

These flags Being, TEMPUR, TEMPOR, ECOMUR, ECOMOR, CRAWUR, CRAWOR, SYSUR, SYSOR & LCINTEG.

## Chapter 8 CANopen® Communication Protocol

This chapter gives details of communication protocols and bus connections.

***This manual only covers CANopen® communications.***

The user will need a suitable CANopen® bus-master application to communicate with DSC.  
(Details of suitable solutions are available from Mantracourt on request).

### ***CANopen® Features Support Summary***

Device Profile	Manufacturer defined (type 0)
NMT support	Slave device
Boot up	Minimum boot up device
COB ID Distribution	by SDO (no DBT support)
Node ID Distribution	by SDO (no LMT support)
PDO's	4tx, 0rx
SDO's	1
PDO modes	Sync, Async, Cyclic, Acyclic
Variable PDO mapping	Y Maximum 2 objects / PDO
Emergency Message	Y
Life Guarding	N
Heartbeat Producer	Y

Additional Notes:

Changes to NodeID, CANbus Bit Rate and PDO communication Parameters will require the device to be power cycled.

## Object Dictionary Summary

DSC & DCELL internal data values are mapped into the object dictionary in three distinct areas :-

1. The main output values are mapped into the 'Device Profile' area, at 6000h onward
2. Special control parameters, specific to the CANopen® version, are at 2000h onward
3. The DCell, DSC internal Configuration parameters are mapped at 5000h onward

Object index	Sub-index	Type	Access	Description	[Default]
1000 -1FFF	-	-	-	Standard communications area	-
2000	0	UNSIGNED8	R/W	CANopen® node id	127 (0x7F)
2001	0	UNSIGNED8	R/W	CANbus bitrate control	3 = 125kb/s
5000 -5FFF	0	SIGNED32	-	DSC internal parameters	-
6000	0	FLOAT32	RO	“SYS” main value output (Scaled)	-
6001	0	UNSIGNED16	RO	DSC “FLAG” error register	-
6002	0	FLOAT32	RO	“SYSN” main value (Snapped SYS Value)	-

The device supports a manufacturer-specific device profile with Limited PDO mapping of 2 objects to each Transmit PDO. The following communications objects are implemented:-

- SDO
- Transmit PDO-1
- Transmit PDO-2
- Transmit PDO-3
- Transmit PDO-4

## Error Management

The DSC “FLAG” value is mapped to the profile object at 6001h. Flags set also cause appropriate bits in the standard Error Register (object index 1001h) to be set.

In some cases, an Emergency telegram is also broadcast. In this case, the “Manufacturer Specific Error Field” simply contains the actual 16-bit “FLAG” value, followed by void bytes.

When the error condition is removed, the error register reverts to 0, and a further “NO error” emergency telegram is sent, if appropriate.

The error and emergency codes generated by DSC error conditions are the following :—

Bit	Value	Description	Error Register Bit(s)	Emergency Telegram Code
0	1	(unused - reserved)	Unused	NONE
1	2	(unused - reserved)	Unused	NONE
2	4	Temperature under range ( TEMP)	0,3 = temp	4200h = device temp
3	8	Temperature over-range (TEMP)	0,3 = temp	4200h = device temp
4	16	Strain gauge input under-range	0,7 = mfr-specd	-
5	32	Strain gauge input over-range	0,7 = mfr-specd	-
6	64	Cell under-range (CRAW)	0,7 = mfr-specd	-
7	128	Cell over-range (CRAW)	0,7 = mfr-specd	-
8	256	System under-range (SRAW)	0,7 = mfr-specd	-
9	512	System over-range (SRAW)	0,7 = mfr-specd	-
10	1024	(unused - reserved)	0,7 = mfr-specd	-
11	2048	Load Cell Integrity Error (LCINTEG)	0,7 = mfr-specd	-
12	4096	Watchdog Reset	0,7 = mfr-specd	-
11	8192	(unused - reserved)	0,7 = mfr-specd	-
14	16384	Brown-Out Reset	0,7 = mfr-specd	-
15	32768	Reboot warning (Normal Power up)	0,7 = mfr-specd	6000h = device software

## Communications Controls

The units NODE ID is configured over the CAN BUS by writing to the object at index 2000h sub index 0.

The Node ID is stored in non volatile memory and changes will not take effect until the unit is power cycled.

Units are delivered with a CANopen® Node-ID set to 127

The CANbus Bit Rate can be configured by writing to the object at index 2001h sub index 0, where the following value settings are defined :-

Setting:	0	1	2	3	4	5	6	7
Rate/kbs	20	50	100	125	250	500	800	1000

If a value < 0 or > 7 is sent to the unit the next time the power is cycled the unit will return to its default Bit rate of 125 Kbits to avoid losing communications with the unit by entering an invalid Bit Rate. It is Essential that the Bit Rate is set correctly or communications with the device will no longer be possible.

Again stored in non volatile memory and changes will not take effect until the unit is power cycled.

On receiving a NMT “Reset\_Node” or “Reset\_Communication” service, all the device-independent communications settings revert to the CANopen® standard default settings. The Node-ID and Bit Rate are not reset by this.

## ***Data Type Conversions and Rounding***

### **Type Conversion**

Depending on the protocol, an integer/byte parameter may need to be converted to or from a floating-point representation for reading or writing.

### **The rules are as follows**

For reading, integer and byte parameters are treated as unsigned, and never read negative

- i.e. read value ranges are 0 to 65535.0 and 0 to 255.0

For writing, values written to integer and byte parameters are truncated to the nearest integer, and negative or positive values are acceptable

**NOTE:** Floating-point data is not always exact, even when reading integral data

e.g. could get 3.999974 instead of 4

e.g. for a byte write 240, 240.1 and 239.66 are all the same value

### **Rounding**

Although rounding is applied when writing to integral values, data read from a device is **not** rounded off.

## Chapter 9 Object Dictionary

This chapter contains tables of all DCell/DSC Object Dictionary, with brief details of each.

### Communications Profile Area

#### Device Description and Communication Specific

Name	Description	Access	Object Dictionary Index	Object Dictionary Sub Index	Data Type
-	DEVICE TYPE	RO	1000h	0	Unsigned 32 bit
-	ERROR REGISTER	RO	1001h	0	Unsigned 8 bit
-	PRE-DEFINED ERROR FIELD	RO	1003h	0	Unsigned 32 bit
-	COB-ID SYNC MESSAGE	RO	1005h	0	Unsigned 32 bit
-	RESTORE ALL PARAMETERS FROM 1000H TO 2001H	WO	1011h	1	Unsigned 32 bit note 1
-	RESTORE COMMUNICATIONS PROFILE PARAMETERS 1000H TO 1FFFH	WO	1011h	2	Unsigned 32 bit note 1
-	RESTORE CAN COMMUNICATIONS NODE ID & BITRATE	WO	1011h	4	Unsigned 32 bit note 1

Note 1 should always be 4 bytes value = "SAVE"

MSB				LSB			
65h	'e'	76h	'v'	61h	'a'	73h	's'

## Transmit PDO Operation Specific

Name	Description	Access	Object Dictionary Index	Object Dictionary Sub Index	Data Type	Default
PDOT1	TPDO 1 transmit Type	RW	1800h	02h	Unsigned 8 bit	255 = Use Event timer
PDOC1	TPDO 1 COBID	RW	1800h	01h	Unsigned 32 bit	0 = Use default of 0x180 + Node ID See Note 3
PDOI1	TPDO 1 Inhibit timer	RW	1800h	03h	Unsigned 16 bit	0 = Disabled
PDOE1	TPDO 1 Transmission interval	RW	1800h	05h	Unsigned 16 bit	100mS
PDOT2	TPDO 2 transmit Type	RW	1801h	02h	Unsigned 8 bit	255 = Use Event timer
PDOC2	TPDO 2 COBID	RW	1801h	01h	Unsigned 32 bit	0 = Use default of 0x280 + Node ID See Note 3
PDOI2	TPDO 2 Inhibit timer	RW	1801h	03h	Unsigned 16 bit	0 = Disabled
PDOE2	TPDO 2 Transmission interval	RW	1801h	05h	Unsigned 16 bit	100mS
PDOT3	TPDO 3 transmit Type	RW	1802h	02h	Unsigned 8 bit	255 = Use Event timer
PDOC3	TPDO 3 COBID	RW	1802h	01h	Unsigned 32 bit	0 = Use default of 0x380 + Node ID See Note 3
PDOI3	TPDO 3 Inhibit timer	RW	1802h	03h	Unsigned 16 bit	0 = Disabled
PDOE3	TPDO 3 Transmission interval	RW	1802h	05h	Unsigned 16 bit	100mS
PDOT4	TPDO 4 transmit Type	RW	1803h	02h	Unsigned 8 bit	255 = Use Event timer
PDOC4	TPDO 4 COBID	RW	1803h	01h	Unsigned 32 bit	0x80000000 = Disabled See Note 3
PDOI4	TPDO 4 Inhibit timer	RW	1803h	03h	Unsigned 16 bit	0 = Disabled
PDOE4	TPDO 4 Transmission interval	RW	1803h	05h	Unsigned 16 bit	100mS

### Note

1. Each TPDO can have a maximum of two objects mapped.
2. PDO Parameters are stored directly to non volatile memory but will not take effect until the device has been re-booted or an NMT reset communications has been issued.
3. 0x80000000 disables the TxPDO otherwise, setting a non zero value will result in this value being used instead.

## Transmit PDO Mapping Specific

Name	Description	Access	Object Dictionary Index	Object Dictionary Sub Index	Data Type	Defaults
PDOP1	TPDO 1 Mapping item 1	RW	1A00h	01h	See details below	0x50050004 'SYS', Sub Index 0, Length of 4 Bytes
PDOS1	TPDO 1 Mapping item 2	RW	1A00h	02h	See details below	0 = Disabled
PDOP2	TPDO 2 Mapping item 1	RW	1A01h	01h	See details below	0x50090002 'FLAG', Sub Index 0, Length of 2 Bytes
PDOS2	TPDO 2 Mapping item 2	RW	1A01h	02h	See details below	0 = Disabled
PDOP3	TPDO 3 Mapping item 1	RW	1A02h	01h	See details below	0x500D0002 'SYSN', Sub Index 0, Length of 4 Bytes
PDOS3	TPDO 3 Mapping item 2	RW	1A02h	02h	See details below	0 = Disabled
PDOP4	TPDO 4 Mapping item 1	RW	1A03h	01h	See details below	0 = Disabled
PDOS4	TPDO 4 Mapping item 2	RW	1A03h	02h	See details below	0 = Disabled

PDO mapping data entries consist of the following data, which are 4 bytes total

First Two bytes are Object dictionary index to be mapped

Third byte is object dictionary sub index

Forth byte is the required data length

Note: The TxPDOs defaults have been mapped to the Manufacturers Specific Profile Area and not the Standardised Device Profile Area.

Name refers to the Instrument Explorer Name.

## Manufacturer Specific Area

Name	Description	Access	Object Dictionary Index	Object Dictionary Sub Index
CMVV	Temp Compensated mV/V	RO	5000h	0
STAT	Status	RO	5001h	0
MVV	Filtered & factory calibrated mV/V	RO	5002h	0
SOUT	Selected output (copy of SYS)	RO	5003h	0
SYS	Main output	RO	5005h and 6000h	0
TEMP	Temperature	RO	5006h	0
SRAW	Raw System output	RO	5007h	0
CELL	Cell output	RO	5008h	0
FLAG	Error flags	RW	5009h and 6001h	0
CRAW	Raw cell output	RO	500Ah	0
ELEC	Electrical output	RO	500Bh	0
SZ	System zero	RW	500Ch	0
SYSN	Snapshot result	RO	500Dh and 6002h	0
PEAK	Peak value	RO	500Eh	0
TROF	Trough value	RO	500Fh	0
SERL	Serial number low	RO	5010h	0
SERH	Serial number high	RO	5011h	0
RATE	Reading rate select	RW	5014h	0
NMVV	Nominal mV/V for scaling ELEC	RW	5015h	0
CGAI	Cell gain	RW	5016h	0
COFS	Cell offset	RW	5017h	0
CMIN	Cell range min	RW	5018h	0
CMAX	Cell range max	RW	5019h	0
CLN	Number of Linearisation points	RW	501Eh	0
CLX1..7	Linearisation raw-values	RW	501Fh .. 5025h	0 .. 0
CLK1..7	Linearisation corrections	RW	5026h .. 502Ch	0 .. 0
SGAI	System gain	RW	502Dh	0
SOFS	System offset	RW	502Eh	0
SMIN	System range min	RW	502Fh	0
SMAX	System range max	RW	5030h	0
USR1..9	User storage values	RW	5031h .. 5039h	0 .. 0
FFLV	Dynamic Filter Level	RW	503Ch	0
FFST	Dynamic filter steps	RW	503Dh	0
CTN	Number of Temperature Compensation points	RW	503Eh	0
CT1..5	Temperature Compensation Point	RW	503Fh .. 5043h	0 .. 0
CTG1..5	Temperature Compensation Gain adjust	RW	5044h .. 5048h	0 .. 0
CTO1..5	Temperature Compensation Offset Adjust	RW	5049h .. 504Dh	0 .. 0
RST	Reset	WO	5050h	0
SNAP	Take snapshot	WO	5051h	0
RSPT	Reset peak & trough	WO	5052h	0
SCON	Shunt cal ON	WO	5053h	0
SCOF	Shunt cal OFF	WO	5054h	0
OPON	Digital Output On	WO	5050h	0
OPOFF	Digital Output Off	WO	5051h	0

### Table Key

“..” - Denotes a range (e.g. CLK1..7 means “CLK1” to “CLK7”)

Access RW/RO/WO/X = read-write / read-only / write-only / execute

## Chapter 10 Installation

This chapter gives detailed information on integrating DCell and DSC devices into a production system - including mounting, protection, adjustments, wiring and electrical requirements.

### Before Installation

Carefully remove the DCell/DSC device from its shipment box. Check that the device is complete and undamaged. Check the Product Type Code - on the product label is that which you ordered.

The DCell/DSC can operate in any industrial environment providing the following limits are not exceeded

Operating Temperature	-40 °C to +85 °C
Humidity	95% non condensing
Storage temperature	-40 °C to +85 °C

For precise details of Environmental Approvals, see chapter 15.

### It Is Advisable To Follow The Following Installation Practice Where Possible

- Minimise vibration
- Do not mount next to strong electrical or magnetic fields (transformers, power cables)
- Install electrical protection device as the unit is not internally fused
- Always ensure the package is secure and protected

### Physical Mounting

DCell is normally sealed in the pocket of the load cell, which provides mechanical and moisture protection, and electrical shielding.

**The DCell should be mounted using a 2mm screw to the body of the load cell. This should be a “Good” electrical connection to obtain maximum performance.**

Connecting wires are soldered directly to the pads on the top and/or bottom of the PCB. Care must be taken to electrically insulate the connection pads from the surrounding metal.

DSC is normally installed in a protective enclosure, such as a metal box.

The pins can be plugged into standard (0.1” pitch) PCB header sockets, or soldered directly into a host board or to connecting wires.

It can be mounted either way up. Unwanted pins projecting on one side may be cropped off.

For extra vibration resistance, the 3 mounting holes provided can be used.

If not required, the protruding end with the single hole can be cut off to make the board smaller.

### Electrical Protection

No additional electrical shielding is normally needed.

Electrostatic protection is sufficient for installation purposes only.

Devices are protected against shorting of communications lines to power supply, and shorting of sensor inputs.

No over-current protection is provided in case of faults, so the supply arrangements should ensure adequate power limiting or fusing.

### NOT PROTECTED AGAINST REVERSE POLARITY OF SUPPLY.

### Moisture Protection

Both DCell and DSC must only be operated in a dry environment, as moisture can dramatically degrade the measurement performance.

#### DCell

Will normally be sealed into a load cell pocket.

While flexible silicone sealant can be used to completely embed the unit, this is not adequate moisture protection in itself.

If required, the entire unit can be embedded in a potting compound: A two-part epoxy compound can be used, but bubbles and gaps must be avoided to prevent mechanical stress which could break the device.

The compound used must be specified for electrical use, and have sufficient thermal conductivity to cope with the heat given off (up to 1W on a 15V supply).

DSC no additional electrical shielding is required, but moisture and/or mechanical protection are often required. Any simple box or enclosure can be used. If metal, the enclosure should be grounded to the SH connection (see Communications Cabling and Grounding Requirements below).

## **Soldering Methods**

Take care soldering cables to the pads. Use a temperature controlled soldering iron set to a maximum 330°C, for no longer than 2 seconds per pad. Excessive heat or increased soldering time may result in damage to the PCB.

### **NOTES:**

1. Solder with water-soluble flux should not be used (even low-residue), as this can leave a surface film which attracts atmospheric moisture, degrading measurement performance.



2. DCell units can be damaged by poor soldering, due to the small nature of the circuit boards: Overheating or applying any pressure to a pad can de solder components on the other side of the board, or cause the pad itself to become detached.

## **Power Supply Requirements**

The power supply needed is nominally 5.6 to 18V DC, but any possible droop or ripple must be included: The devices contain 'brown-out' detection, which may trigger if the supply voltage at the device drops below the 5.6 volts.

A single device consumes typically 40mA with a 350Ω gauge connected (except RS232-output units, which use about 10mA more).

An installation should therefore assume at least 60mA per unit, and allow for extra current being taken at power-on (though supply voltage can safely drop temporarily), and for possible voltage drops in long cables.

Any power-supply ripple should be below 100mV, and supply arrangements should provide current limiting for fault conditions (see *Electrical Protection*, above).

## **Cable Requirements**

### **Strain Gauge input (DSC)**

For optimal performance twin twisted pair with individual shields is recommended, this gives good noise immunity. Maximum length should not exceed 20m. Normal 4 core shielded cable can be used in areas of low electromagnetic noise.

### **Power and Communication**

Again, twin twisted pair cable is recommended for this. The cable should have the following characteristics.

- Twisted-pair with independent shields
- Characteristic impedance 50-150 ohms.
- Core to core and core to shield capacitance below 300pF/m

A suitable type is BICC Brand-Rex BE56723 (also equivalent to Belden type 8723).

In the UK, this is available from Farnell, part number 118-2117

### **Temperature Sensor**

A shielded twisted pair is recommended, with a maximum length of 10m the shield being connected to the load cell body or (CH if DSC). For short lengths (< 2m) in a low noise environment (inside load cell body for example) then normal cable can be used.

## Identifying Strain Gauge Connections

### DCell Input Connections

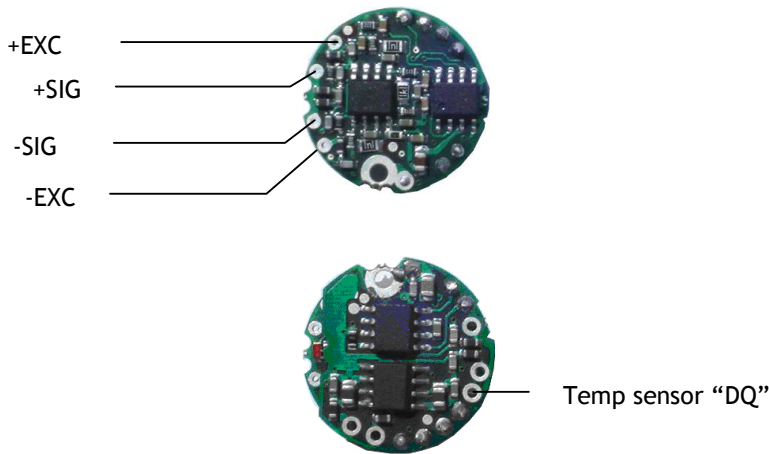

The Optional Temperature sensor has two connections, "DQ" which provides the bi-directional data line and -EXC which provides the 0v connection.

### DSC Input Connections



Strain Gauge Bridge Connections Are As Follows

- EXC+/- positive/negative excitation (supply)
- SIG+/- positive/negative output signal
- SH Shield connection for shield of strain gauge cable
- GND can be used as the ground connection for the temperature sensor

### Other Connections (DSC ONLY)

Resistor RG and track-cut TC are used to adjust the mV/V sensitivity (see *Strain Gauge Sensitivity Adjustment*, below).

## Identifying Bus-End Connections

### DCell Bus Connections

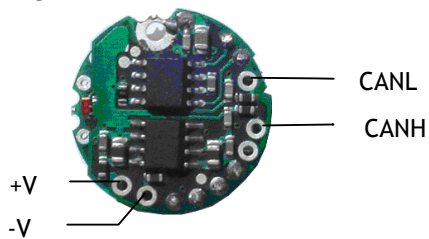

## DSC CAN Versions-Bus Connections



- +V and -V are the DC power-supply and return connections
- CANH & CANL are the CAN communications connections
- GND is a communications ground connection
- SH is the shield ground, used for shielding and grounding only
- OP is the open collector digital output
- IP is the volt free digital input
- TS connects to DQ of the optional temperature sensor

## Strain Gauge Cabling and Grounding Requirements

To achieve full performance specifications and conform to environmental approvals, it is important to follow the wiring procedures outlined in this section.

### DCell Strain Gauge Wiring

The following diagram illustrates how to wire up a DCell to a strain gauge

#### DCell Strain Gauge Wiring Arrangement

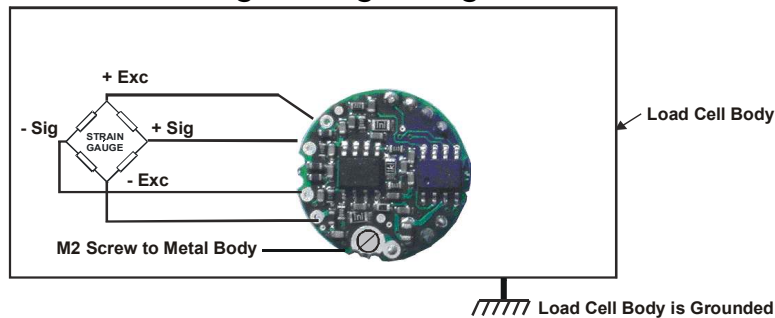

### Key Requirements

All the load cell wires should be kept as short as feasible, at most 20cm.

The EXC+/- wires should be twisted together, also the SIG+/- pair, and the two pairs kept apart. It is also recommended to secure the wires from moving due to shock or vibration. If the DCell is mounted outside the body of the load cell then, for optimal performance, twin twisted cable should be used, although standard 4 core shield cable can be used in low noise environments.

The M2 mounting hole **must be grounded** via an M2 screw to the load cell body for specified performance to be met. (The 2mm mounting hole to accept M2 screw or American equivalent #0-80. Important Note: DO NOT USE #2 screw size.)

## DSC Strain Gauge Cabling Arrangement

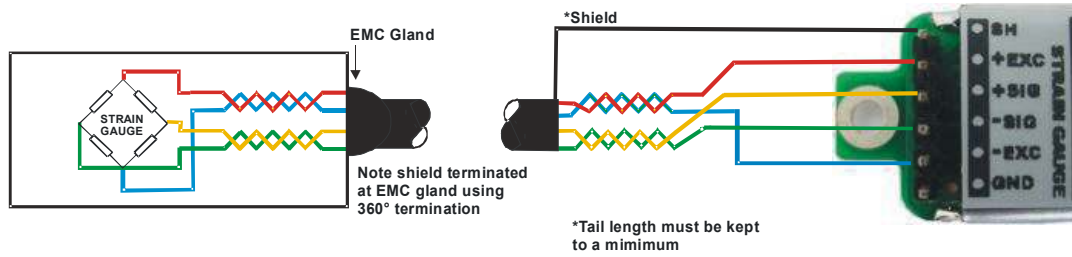

### Key Requirements

The Strain Gauge cable should be a twin twisted pair with independent shields, with the two pairs used for the EXC and SIG signal-pairs.

For specified performance, the load cell must be grounded to the SH.

### DSC Sensor Cable

require 2 × twisted-pair version, otherwise similar to the above.

A suitable type is BICC Brand-Rex PD3003 (also equivalent to Belden type 8777).

In the UK, this is available from Farnell (enter 'Belden 8777' for real length options).

## Communications Cabling and Grounding Requirements

To achieve full performance specifications and conform to environmental approvals, it is important to follow the wiring procedures outlined in this section.

### DCell Power and Communications Wiring

The following diagram illustrates how to connect a puck to the communications and power supply (“bus”) cable.

#### DCell Bus-End Arrangement

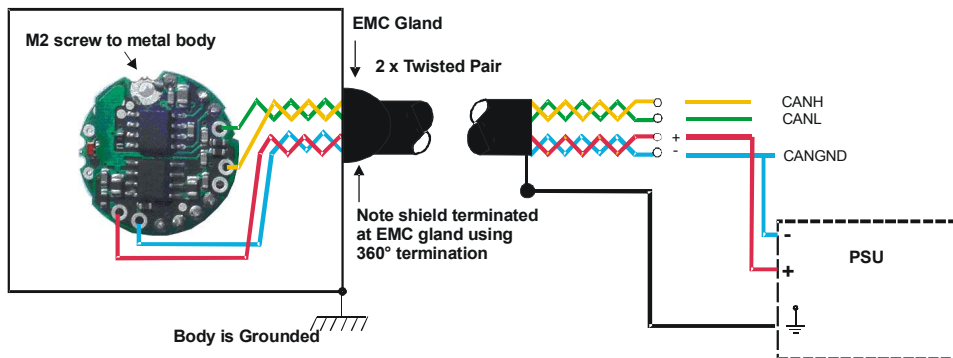

*Note: The specified cable above shows a yellow wire this will be replaced with a white wire.*

#### Key Requirements

The cable must enter the load cell via an EMC cable gland, which connects the cable shield to the load cell body. This must be a 360 Degree connection

The cable should be a twin twisted pair with independent shields, with one pair used for the communications and the other for the power wires.

There **MUST** be a common connection from the PSU and the CAN ground to ensure the CAN stays within the required common mode voltage of -2v (CANL) to +7v (CANH).

The shield should be connected to the grounded enclosure of the power supply.

## DSC4 Versions- Power and Communications Wiring

The following diagram illustrates how to connect a DSC4 card to the communications and power supply (“bus”) cable.

### DSC4 Versions-Bus-End Arrangement

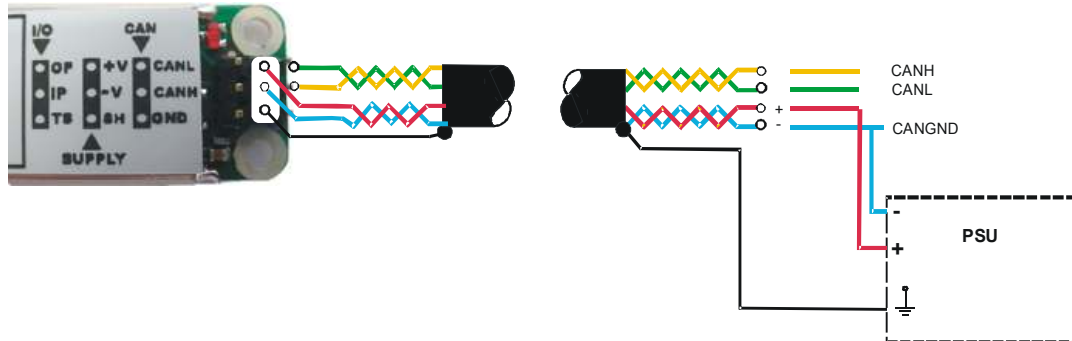

*Note: The specified cable above shows a yellow wire this will be replaced with a white wire.*

### Key Requirements

The cable should be a twin twisted pair with independent shields, with one pair used for the communications and the other for the power wires.

The cable shield must be grounded to the SH pin at the DSC end, and *not* at the host end.

Any further metal housing should also be grounded to the DSC pin, and should *not* be connected to the bus cable shield (or the sensor cable).

There **MUST** be a common connection from the PSU and the CAN ground to ensure the CAN stays within the required common mode voltage of -2v (CANL) to +7v (CANH).

### Suitable Cable Types

#### DCell/DSC CAN Bus Cable

The Cable requirements are dependent on the bit rate of the CAN bus and the required distances. Special care is required for bit rates of over 500Kbps not only in the choice of cable used but how the bus wiring is organised ie the requirement for very small stub lengths for high bit rates.

#### For low bit rates the requirements can be specified as follows

A suitable type is BICC Brand-Rex BE56723 (also equivalent to Belden type 8723).

In the UK, this is available from Farnell, part number 118-2117

#### For bit rates above 500Kbps the following is recommended

Belden B3084A

Belden B8132

## CAN Bus Connections for Multiple DCells

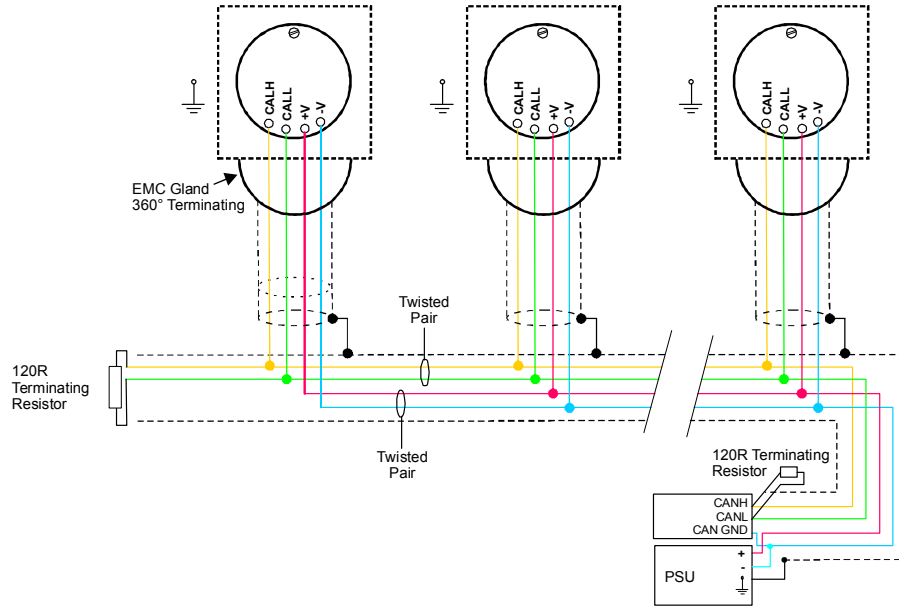

## CAN Bus Connections for Multiple DSC Versions

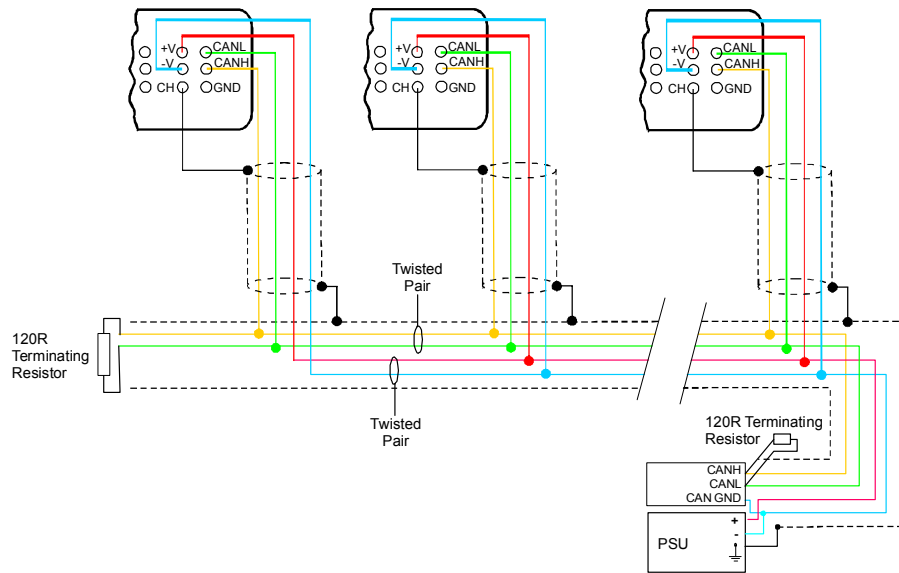

Note : The specified cable above shows a yellow wire this will be replaced with a white wire.

## Key Requirements

- The main bus cable must be terminated at either end.
- Where the bus does not go directly to each attached device, each 'stub' cable connecting to the bus should have just one device on it.
- Stub branches should be kept as short as possible.
- Stubs are not terminated.

## Bus Layout and Termination

The ideal bus is a single length of cable, terminated at either end. Each end connects to a communicating device; while other devices are connected as near as possible directly to the main bus as it passes them (i.e. not on long side-branches).

The bus must be terminated at both ends to avoid reflections. Connecting a 120 Ohm resistor between the CANH and CANL lines does this.

## Loading

It is important that the bus is loaded at each end with the corresponding line impedance, this is normally 120Ohm

## Strain Gauge Sensitivity Adjustment (DSC ONLY)

For DCell strain gauge sensitivity adjustment please consult factory.

If your strain gauge does not deliver a 2.5mV/V full scale output, you may want to adjust the sensitivity of the electronics (hardware) and/or the software gain controls.

If you want to test with an input of *more* than 2.5mV/V, you will have to adjust the hardware sensitivity to avoid saturating the input. If it is less, you can correct in software alone, but increasing sensitivity will generally improve accuracy.

To adjust the mV/V for DSC, an extra resistor 'Rg' is fitted across the pads RG, as shown above, in

## Identifying the DSC 'Rg' Resistor

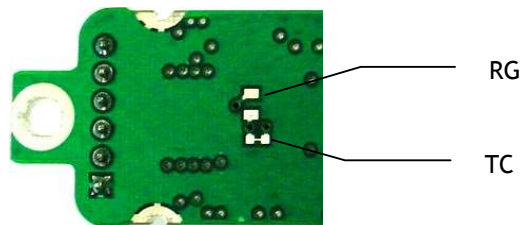

## Identifying Sensor End Connections

The link across TC can be cut to disconnect the internal 100R gain resistor: This is needed for lowering the sensitivity.

The resistor is 0805 size surface mount chip.

A 0.1%, 5ppm/Deg C resistor for the high stability version & 25ppm/ Deg C for the Industrial must be used to maintain performance.

## Reducing Sensitivity

To accommodate a maximum sensor output *larger* than 2.5mV/V, it is necessary to reduce the electrical sensitivity of the input circuitry.

To decrease sensitivity, the link TC is cut, and the value of the resistor fitted, in  $\Omega$ , should be -

$$R_g = (\text{required mV/V}) \times 40$$

Example: For 10mV/V

$$R_g = 10 \times 40 = 400\Omega$$

### Increasing Sensitivity

When the full-scale output is *smaller* than 2.5 mV/V, it may be desired to increase sensitivity. However, it is often possible instead to compensate partly or entirely in software, by increasing a software gain control CGAI or SGAI

To *increase* sensitivity, TC is left in place, so that the fitted Rg appears in parallel (this gives better temperature stability). Its value should then be

$$RG = 1 / (( 0.025 / r_{qd} \text{ m V/V } ) - 0.01)$$

### Two effects should be noted

1. The purpose of increasing sensitivity is to reduce reading *noise*, which governs the effective resolution. Using software gain alone obviously gives reduced performance.
2. The sensitivity should, however, not be set greater than typically 1mV/V: Beyond this, input noise usually dominates and no extra benefit can be achieved.

# Chapter 11 Troubleshooting

This chapter gives a quick guide to problem solving for DCell/DSC devices.

Bear in mind that the quickest way to pin down problems is to usually replace items with 'known good' alternatives. This also applies to cables, power supplies, devices etc.

## LED Indicator

The LED is used to indicate the protocol selection, the device is powered and the Device is Operating. For correct operation the LED should Flash ON for 100mS then repeat at a rate depending on the protocol. See table below. If this is not the case then follow the instructions below.

If the LED is OFF check the power supply polarity & voltage. The voltage including any troughs should be above 5.6V and less than 18V. If the supply polarity and voltage is correct then switch off, remove the strain gauge from circuit and switch on. If the LED is still off check the current drawn by the device. With no strain gauges should be approx 30mA.

If the LED is permanently ON then contact factory.

If The LED is ON for the majority of time then Flashes OFF for 100mS then a fault exists. This Fault can be read back using the communications. Likely causes of this are Strain Gauge Integrity error or Limits reached for MVV, CRAW, SRAW or TEMP. First check the connections to the strain gauge are correct. Next check the input is not over-range or the limits set for CMIN, CMAX, SMIN or SMAX have not been exceeded.

## No Communications

The majority of problems involve a failure to communicate, as there are a number of optional settings that must be set the same at both ends of the link.

For this reason, any communications application should always check command responses, and flag a problem when there these responses are not activated.

Possible problems can be categorised according to where in the 'chain' of communication the problem may be. The typical chain runs as follows,

- PC software (port connection, baud rate, Node ID, protocol)
- PC USB (working)
- PC CAN drivers
- USB-CAN device
- Bus wiring
- Device (wiring, ID, bit rate, working)

## Bad Readings

The cause can be either hardware or software related.

### Software

1. Check the MVV reading first and ensure it is correct. This figure is the RAW input and is not affected by the user configurable calibration settings.
2. If MVV looks correct, check the calibration settings step by step.  
Consider resetting all the calibration controls to default values - see *Calibration Parameters Summary and Defaults* in *Chapter 4 The Readings Process*. Hardware
3. Load Cell problem should be indicated by Flag LCINTEG in STAT.
4. Genuine hardware problems usual show up as **total** failure - i.e. no reading = always unchanging, usually near zero, sometimes always full-scale.  
Check wiring, take voltage level readings and again if possible use a known good device and set up.
5. Check the sensor is connected properly, and has some resistance across excitation wires, and around 350 Ohms across output wires (when disconnected from device).
6. Check for damaged DCell/DSC device by replacement

## Unexpected Warning Flags

Remember that all warning flags in **FLAG** must be explicitly reset -they do not clear themselves when a problem is resolved.

If a flag cannot be cleared, the cause must be persistent -i.e. it keeps happening again. This can be immediate, regular (every few seconds) or irregular (occasional).

See *Self Diagnosis* for precise details of how the individual warnings operate.

### Bear In Mind The Following Possible Problems

1. REBOOT or COMMSFAIL may indicate intermittent connections.
2. Where ECOMUR/OR or EXCUR/EXCOR are triggered, suspect input wiring.
3. Various 'range' errors (CRAWUR/OR, SRAWUR/OR) are also likely to be set if the excitation was interrupted (EXCUR/OR).
4. For range errors, check the associated limit parameters (CMIN/MAX, SMIN/MAX).
5. Problems are likely if any calibration MIN/MAX parameters are set the wrong side of zero (i.e. MIN>0 or MAX<0).

## Problems with Bus Baud Rate

There are a number of special difficulties to be considered here

- Systems with very long cabling may not work with higher bit rates
- Always remember you need to reboot devices before the change takes effect

Difficult problems can always be overcome, if necessary, by isolating individual devices and trying the different bit rates in turn. This deals with all possible problems, as long as your hardware can deliver all the supported baud rates.

## Recovering a "lost" DCell/DSC

### Resetting to default ID

Due to the configure ability of the devices CAN settings it is important to note all changes made to these settings or you may lose the ability to communicate with the device. In particular if the ID is changed from the default it would be very difficult to find the ID by trial and error as there are 2047 possible ID's available on a Can 2.0a 11 bit system and 536,870,911 for Can 2.0b 29 bit identifiers.

For this reason the DSC has a built in mechanism to reset the base ID back to the default value of 1.

To activate this recovery mode the device must be sent 2 commands over the CAN Bus on the broadcast ID of 0 with the second command being sent within 2 seconds of the first.

It is important that the device to be reset is the only device to be connected on the CAN bus otherwise all devices will be reset to the default!!

Each Command consists of 7 ASCII Bytes as its Data message bytes shown below.

### First Command

	Byte							
	1	2	3	4	5	6	7	8
ASCII	M	A	N	T	R	S	T	Blank
DECIMAL	77	65	78	84	82	83	84	Blank
HEX	4D	41	4E	54	52	53	54	Blank

### Second Command

must be sent within 2 seconds of First Command

	Byte							
	1	2	3	4	5	6	7	8
ASCII	D	O	R	E	S	E	T	Blank
DECIMAL	68	79	82	69	83	69	84	Blank
HEX	44	4F	52	45	53	45	54	Blank

After sending the command sequence recycle the power to the DSC the DSC will then have the default base ID of 1.

## Chapter 12 Specifications

### Technical Specifications DSC/DCELL High Stability

Set for 2.5mV/V sensitivity.

Parameter	Min	Typical	Max	Units
Strain Gauge Excitation System	4 Wire			
Strain Gauge Excitation Voltage	4.5	5	5.25	VDC
Strain Gauge Drive Capability	320	-	5000	Ohms
Strain Gauge Sensitivity	-3	2.5	3	mV/V
Offset Temperature Stability		1	4	ppm/C
Gain Temperature Stability		3	5	ppm/C
Offset Stability with Time		20	80	ppm of FR (1)
Gain Stability with Time			30	ppm of FR (2)
Non Linearity before Linearization		5	25	ppm of FR
Internal Resolution		16 Million		Counts/divs
Resolution @ 1Hz readings (Noise stable) over 100s		200,000		Counts/divs
Resolution @ 10Hz readings (Noise stable) over 100s		120,000		Counts/divs
Resolution @ 100Hz readings (Noise stable) over 100s		50,000		Counts/divs
Signal Filter	Dynamic recursive type user programmable			
<b>Optional Temperature Resolution</b>				
Temperature Measurement Resolution		0.0625		Deg C
Temperature Measurement Accuracy (-10 to 85)		0.5		Deg C
Temperature Measurement Accuracy (-55 to 125)		2.0		Deg C
Temperature update Speed		5		Seconds
<b>Electrical</b>				
Power Supply voltage	5.6	12	18	V dc
Power Supply ripple			100	mV ac pk-pk
Power Supply current (350R Bridge)		45	60	mA
Power @ 10v (350R Bridge)		450		mW
<b>Environmental</b>				
Output Data terminal	CAN 2.0B			
Data transmission rate	20K	-	1M	bps
Output cable length (speed dependant)			1000	m
Operating temperature range	-40		+85	C
Storage temperature	-40		+85	C
Humidity	0		95	%RH
PCB Dimensions DSC	87.4 x 20 x 8.5mm			
PCB Dimensions DCell	Diameter 20mm, Height 10mm			

Notes.

1. From original offset at any time
2. 1st Year
3. Dependent on cable type and bit rate.

The DSC digital output is an open collector transistor rated at 100mA @ 40v

## Technical Specifications DSC/DCell Industrial Stability

DSC Conditioner is nominally set for 2.5mV/V sensitivity.

Parameter	Min	Typical	Max	Units
Strain Gauge Excitation System	4 Wire			
Strain Gauge Excitation Voltage	4.5	5	5.25	VDC
Strain Gauge Drive Capability	320	-	5000	Ohms
Strain Gauge Sensitivity	-3	2.5	3	mV/V
Offset Temperature Stability		5	10	ppm/C
Gain Temperature Stability		30	50	ppm/C
Offset Stability with Time		35	160	ppm of FR (1)
Gain Stability with Time			300	ppm of FR (2)
Non Linearity before Linearization		5	25	ppm of FR
Internal Resolution		16 Million		Counts/divs
Resolution @ 1Hz readings (Noise stable) over 100s		66,000		Counts/divs
Resolution @ 10Hz readings (Noise stable) over 100s		40,000		Counts/divs
Resolution @ 100Hz readings (Noise stable) over 100s		10,000		Counts/divs
Signal Filter	Dynamic recursive type user programmable			
<b>Optional Temperature Resolution</b>				
Temperature Measurement Resolution		0.0625		Deg C
Temperature Measurement Accuracy (-10 to 85)		0.5		Deg C
Temperature Measurement Accuracy (-55 to 125)		2.0		Deg C
Temperature update Speed		5		Seconds
<b>Electrical</b>				
Power Supply voltage	5.6	12	18	V dc
Power Supply ripple			100	mV ac pk-pk
Power Supply current (350R Bridge)		45	60	mA
Power @ 10v (350R Bridge)		450		mW
<b>Environmental</b>				
Output Data terminal				
Data transmission rate	20K	-	1M	bps
Output cable length (speed dependant) Note 3			1000	m
Operating temperature range	-40		+85	C
Storage temperature	-40		+85	C
Humidity	0		95	%RH
PCB Dimensions DSC	87.4 x 20 x 8.5mm			
PCB Dimensions DCell	Diameter 20mm, Height 10mm			

Notes.

1. From original offset at any time
2. 1st Year
3. Dependent on cable type and bit rate

The DSC digital output is an open collector transistor rated at 100mA @ 40v



## Warranty

All DCell & DSC products from Mantracourt Electronics Ltd., ('Mantracourt') are warranted against defective material and workmanship for a period of (3) three years from the date of dispatch.

If the 'Mantracourt' product you purchase appears to have a defect in material or workmanship or fails during normal use within the period, please contact your Distributor, who will assist you in resolving the problem. If it is necessary to return the product to 'Mantracourt' please include a note stating name, company, address, phone number and a detailed description of the problem. Also, please indicate if it is a warranty repair.

The sender is responsible for shipping charges, freight insurance and proper packaging to prevent breakage in transit.

'Mantracourt' warranty does not apply to defects resulting from action of the buyer such as mishandling, improper interfacing, operation outside of design limits, improper repair or unauthorised modification.

No other warranties are expressed or implied. 'Mantracourt' specifically disclaims any implied warranties of merchantability or fitness for a specific purpose. The remedies outlined above are the buyer's only remedies. 'Mantracourt' will not be liable for direct, indirect, special, incidental or consequential damages whether based on the contract, tort or other legal theory.

Any corrective maintenance required after the warranty period should be performed by 'Mantracourt' approved personnel only.



Ⓒ In the interests of continued product development, Mantracourt Electronics Limited reserves the right to alter product specifications without prior notice.

Designed and Manufactured In the UK

Code No 517-160	Issue 3.0	21.01.10
-----------------	-----------	----------