



ADW15-FPT Fast Input Weighing Indicator / Controller



User Manual
www.mantracourt.co.uk

ME mantracourt

The ADW15 Quick User Guide

The Front Control Panel

All user controls, displays and indicators are mounted on the front panel which provides a 4.5 digit, LED display four flush mounted keys and three LED indicators.

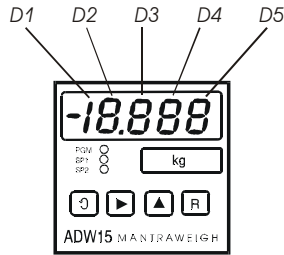







The front panel components are identified as follows:-

- D1 - 1/2 digit
- D2 - Decade 1
- D3 - Decade 2
- D4 - Decade 3
- D5 - Decade 4

- PGM - Program Mode
- SP1 - Set Point 1
- SP2 - Set Point 2



Front Panel Guide

 Used to scroll through and change the set up data by displaying mnemonics for each configurable parameter, followed by the appropriate data. When in programming mode it should be noted that the first digit in the display may not be visible, but the program indicator light PGM will be flashing to indicate that the instrument is in programming mode, even though no digits can be seen to be flashing. The  key has a secondary function when not in programming mode. In conjunction with the  key a print function can be initiated. (If a print option is fitted.)

 The  key has a secondary function when not in programming mode. In conjunction with the  key a print function can be initiated. (If a print option is fitted.)

Selects the display digit required. Selection value is indicated by a flashing digit and flashing PGM indicator light.

It also operates as a control key in conjunction with:

- The  key for a print function from the rear panel remote.
- The  key for Peak Hold / Latched Relay Reset
- The  key for an Auto Tare function.

 Increments each selected display digit 0-9.



Pressing the  key under programming conditions will display the leading digit as either 1, -1, or a blank display for zero.

The secondary function operates as a Peak Hold / Latched Relay Reset in conjunction with the  key.



 Resets the display to the input variable and enters new data in the ADW15-FPT memory. Returns the display to the current value after Hold.

The secondary function operates an Auto Tare in conjunction with the  key

NOTE: Secondary functions require the  key to be pressed and released, followed within 1 second by the appropriate function key.

 then  for Print Select

 then  for peak Hold/Latched Relay Reset



 then  for Auto Tare

The Configurable Parameters

These parameters or programmable functions are provided in the ADW to allow the user good flexibility for monitor and control applications.

Parameters are included as constants in the ADW database and are accessed and checked via the keypad or the communications port.



Data which is entered by the user is retained by EEPROM for up to 10 years without back up power.

New data, when entered, overwrites previous entries when the  or  key is pressed unless the EEPROM has been disabled via the communications port.

Password Protection

To prevent unauthorised changes to parameters, other than Set Points and In Flight compensation settings, a 4 digit password number must be entered. The number is accessed by scrolling through the Set Points and In Flight settings until 'PASS' is displayed. At this point, it is necessary to enter either the factory set number (1111) in D2 - D5 positions, or the password number specifically ordered by the customer.

Configurable Parameters

DISPLAY	FUNCTION	RANGE	FUNCTION
SP1	Set Point1	±19999	'desired' trip value of output 1
IF1	In-flight	±19999	Compensation for SP1 Relay 1 operates at = SP1 - IF1
SP2	Set Point 2	±19999	'desired' trip value of output 2
IF2	In-flight	±19999	Compensation for SP2 Relay 2 operates at = SP2 - IF2
PASS	Security	±19999	Correct value required to Password proceed further
HYS	Hysteresis	0-19999	Amount applied to SP1 and SP2
OA	Output	0-31	Relays energise or de-Action energise above SP level. Analogue output normal or inverted, and latching. The value of the OA to be entered in the algebraic sum of the following components:- SP1 Inverted =1 SP2 Inverted =2 AN-OP Inverted =4 SP1 Latched =8 SP2 Latched =16
CALL	Calibration Low	±19999	Display value for low calibration point (Must be less than CALH)
CALH	Calibration High	±19999	Display value for high calibration point Note: When CALH = 0, the ADW enters manual calibration mode and display scaling is -19999 to +19999
At	Auto Tare	±19999	Value
dA	Display Averaging & Peak Hold	0-15	Sets a display average update. Readings may be averaged over a number of updates and can be set as follows: Display update time 0=1 readings (standard) approx 0.4S 1=2 readings approx 0.8S 2=4 readings approx 1.6S 3=8 readings approx 3.2S 4=16 readings approx 6.4S 5=32 readings approx 12.8S 6=64 readings approx 25.6S 7= Fast update mode approx 0.1S A peak hold function, which will display the highest recorded value of the measured input, can be set by adding 8 to any of the above settings. To reset Peak Hold press the  key, then within 1 second, press the  key.
OPL	Output Low	±19999	(minimum) Display point for minimum analogue output
OPH	Output High	±19999	(maximum) Display point for maximum analogue output
dP-r	Decimal Point & Reset	Code dP Position 0 19999 1 1.9999 2 19.999 3 199.99 4 1999.9 5 19999. Set by code in range 0 to 61	To set the required position of the decimal point on the display and to set the rear contact actions for count reset &/or peak hold &/or latched relay reset or print. Or any of the above combination of these. To make reset input active on any or all of the following add to dP-r No.as follows: 8 Reset Auto-tare 16 Reset latched relays or peak hold (NOTE: Latched relays are not available with peak hold) 32 Activate print
cP	Serial Device	0-129	Comms Protocol. 0-127 = Printer. 128 = 'FAST MANTRABUS'. 129 = 'ASCII'
SdSt	Station Number	0-254	This is the address code for each ADW when the communications port is used. NB: Changes can only be made via the keypad Refer to ADW15 manual.
OR			
LAB			Selects the desired label for the printer.
Ln		0-255	Log Number. Increments on each print, can be set to any start value
rS		0 & 1	Sets Display Resolution = Resolution of 1 least significant digit
InP	Input Variable	2-255	= Resolution setting of last digits Automatically returns the ADW to the input after scrolling sequence and updates permanent memory

Note: Invalid parameter values - Should an invalid figure be entered against any parameter, it will be rejected and the display will return to show the parameters mnemonic.

The 6 Wire Strain Gauge

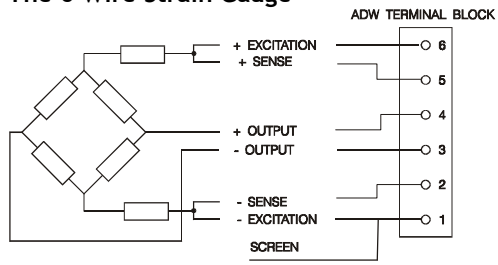

Note: When using 4 wire strain gauges link 1 to 2 and 5 to 6

Contents Page	
The ADW15 Quick User Guide	1
Chapter 1 Introduction to ADW15-FPT.....	6
Chapter 2 Installing The ADW15-FPT.....	8
Environmental Requirements	9
Unpacking.....	9
Equipment	9
Terminal Boards.....	9
Figure 2.1 - Fixed Terminal Board (Panel Mounted)	10
Figure 2.2 - Dimensions For Panel Mounting	10
Figure 2.3 - Din Rail Mounted Terminal Board (Din 1 and Din 3)	10
Figure 2.4 - Dimensions of Din Connector	10
Connecting The Power Supply	10
Connecting The Outputs	11
Reset Terminals	11
Figure 2.3 - The 4 Wire Strain Gauge	11
Figure 2.4 - The 6 Wire Strain Gauge	12
Chapter 3 The ADW15-FPT Controls and Parameters	13
The Front Control Panel	13
Figure 3.1 - Front Panel Layout	13
Front Control Panel Guide	13
Table 3.1	13
Figure - 3.2 Keypad Security Links.....	14
The Configurable Parameters.....	14
Password Protection	14
Table 3.2 Configurable Parameters.....	15
Chapter 4 Strain Gauge Input to the ADW15-FPT	16
The Strain Gauge Input	16
Hardware Configuration:	16
Auto Calibration	17
Auto Tare	17
Display Averaging (dA)	17
Table 4.1	17
Selection of 'Live', 'Peak' and 'Trough' (Valley) Readings	18
Chapter 5 Relay Output Module	19
General Description	19
Table 5.1	19
Module Functions	19
Set Points (SP).....	19
In Flight Compensation	20
Hysteresis (HYS).....	20
Output Action (OA)	20
Latching Outputs.....	20
Chapter 6 Analogue Outputs	21
Module Types	21
Output Scaling.....	23
Method of Calculating OPL & OPH from any known output values.....	24
Chapter 7 The Communications Port.....	26
Serial Communication Protocol	26
MANTRABUS - selected when CP is 128	26
Operation	26
Updating.....	26
Communications Commands	27
Command Ø Request Peak/Trough and Live Displays:	27
Response to Command Ø	27
Command 1 Request for All Data:	27
Response To Command 1 From ADW15-FPT.....	28
Command 2 Request Display Data	28

Response To Command 2 from ADW15-FPT	28
Commands 3 TO 18: Write data to ADW15-FPT Parameter.....	29
Response to Command 3 to 22	29
Command 19: EEPROM Enable / Disable.....	29
Command 20: Output Relay Reset	30
Command 21: Auto Tare.....	30
Command 22: Peak Hold Reset.....	30
ASCII Format - selected when CP is 129	31
Instruction Set for ASCII Serial Communications	32
ADW15-FPT15 Printer Format	32
Chapter 8 Trouble Shooting Guide.....	37
Chapter 9 ADW15-FPT Specifications	39
Speed of Response from Display to Analogue Output	39
Control / Alarm Relay Outputs	40
The Communications Port Data	40
Data Retention and Protection	40
Keypad Security	40
CE Approvals.....	41
ADW15-FPT Accessories	42
W A R R A N T Y	43

Chapter 1 Introduction to ADW15-FPT

The ADW15-FPT is the Fast Input version of the ADW15 with a Peak and Trough display option, and is a compact microprocessor based unit specifically designed to indicate and control weighing applications. Its flexibility of design allows for the connection of most strain Gauges, pressure or strain Gauges.

The industry standard 72 x 72mm front panel offers a full 4.5 digit LED display, together with a 4 key arrangement for programming and reviewing the parameters. Programming and set point LEDs complete the layout.

The basic unit offers the following facilities:- Auto Calibration of high and low values, an easy Auto Tare setting and review. A password facility giving protection to parameters which would not normally be changed by the operator.

Several output options are available:- A relay output module in one of three variants provides for up to two Set Points, Hysteresis can be applied to both Set Points together with In Flight compensation. Relays can be both inverted and latched. All these facilities being set digitally, in real engineering terms from the keypad.

A dc Analogue Output can be selected from a range of five modules, with full scaling over any desired range and inversion if necessary, all set from the keypad.

Both relay and analogue outputs have a high level of isolation. A communication module provides for a 20mA, noise immune current loop linked to a PC, PLC or Main Frame. This allows for the display to be viewed and the parameters changed.

Multiple ADW15-FPTs can be connected via an IF25 RS232 Interface, which can be combined to expand to 254 ADW15-FPTs. A direct RS232 printer port is available for TDP and DP type printers. Power supply modules are available for 240 or 110 volts ac or 9-32volts dc or 18-60v dc. The ADW15-FPT can be mounted in a panel, DIN rail or in a wall mounting case to take up to four units.

(A front panel gasket sealed to IP65 is supplied.) Any set up values which are entered will be protected and retained for up to 10 years, upon power failure.

The ADW15-FPT is an application specific device, based upon the ADP 15 multi-application family of units.

Figure 1.1 Bagging

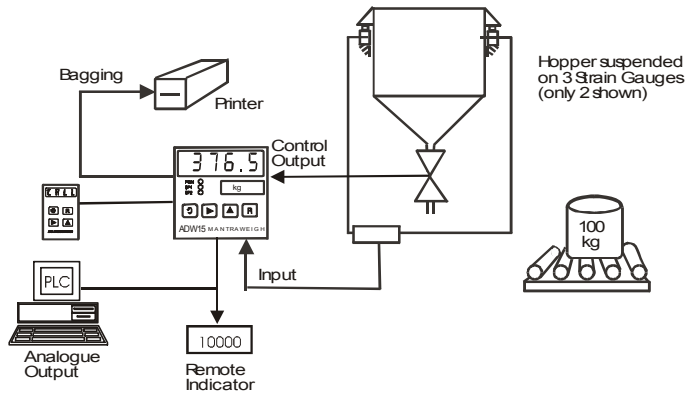

Figure 1.2 Drum Filling

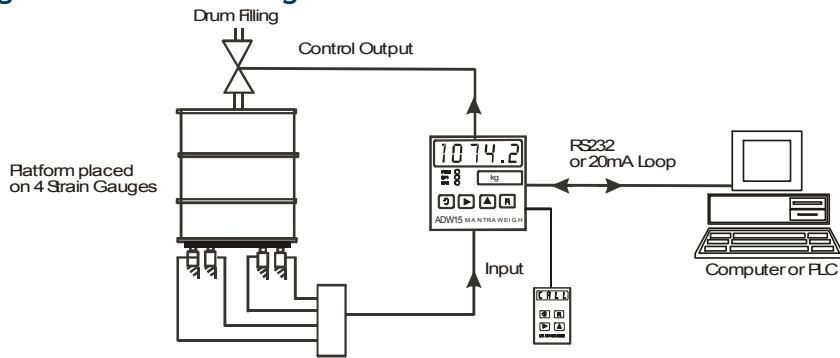
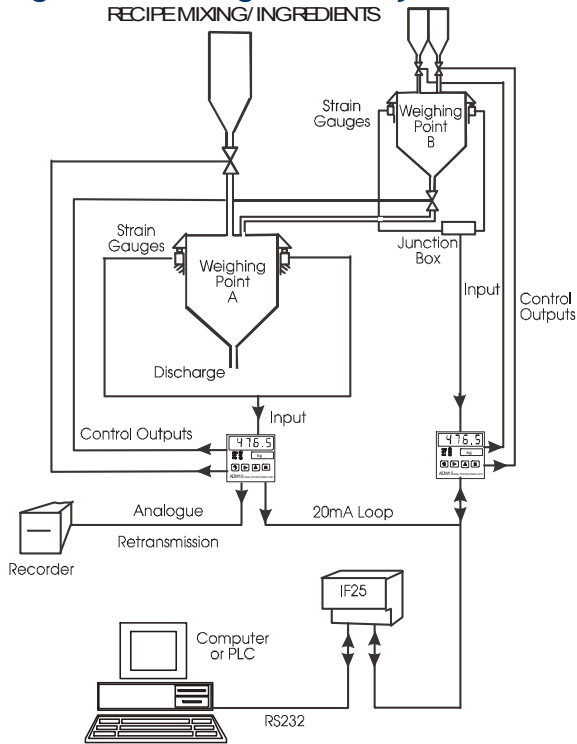

Figure 1.3 Mixing Control by PC



Chapter 2 Installing The ADW15-FPT

In order to maintain compliance with the EMC Directive 2004/108/EC the following installation recommendations should be followed.

Inputs: Use individually screened twisted multipair cable. (e.g. FE 585 - 646)
The pairs should be :
pins 1 & 6
pins 2 & 5
pins 3 & 4
Terminate all screens at pin 1 of the input. The screens should not be connected at the transducer end of the cables.

Comms Port: Use individually screened twisted multipair cable. (e.g. FE 118-2117)
The pairs should be:
-Tx & +Tx
-Rx & +Rx
Terminate screens at pin 1 of the input.
The screens should not be connected at the host port.

**Analogue
Output:**

Use screened twisted pair cable. (e.g. RS 626-4761)

Terminate screen at pin 1 of the input.
The screen should not be connected at the host port.

Pin 1 of the input should be connected to a good Earth. The Earth connection should have a cross-sectional area sufficient enough to ensure a low impedance, in order to attenuate RF interference.

Cable Information (For Reference only)

Country	Supplier	Part No	Description
UK	Farnell	118-2117	Individually shielded twisted multipair cable (7/0.25mm)- 2 pair Tinned copper drain. Individually shielded in polyester tape. Diameter: 4.1mm Capacitance/m: core to core 115 pF & core to shield 203 pF
UK	Farnell	585-646	Individually shielded twisted multipair cable (7/0.25mm)- 3 pair Tinned copper drain. Individually shielded in polyester tape. Diameter: 8.1mm Capacitance/m: core to core 98 pF & core to shield 180 pF
UK	RS	626-4761	Braided shielded twisted multipair cable (7/0.2mm)- 1 pair Miniature- twin -round Diameter: 5.2 mm Capacitance/m: core to core 230 pF & core to shield 215 pF

Environmental Requirements

ADW15-FPT units can operate in any industrial environment provided the following limits are not exceeded at the point of installation:

Temperature: -10 °C to 50 °C

Humidity: 95 % non condensing

Four power supply options are available and must be specified on ordering.

Units can operate from any one of the following:

220/240V AC, 50/60Hz 10W

110V AC, 50/60Hz 10W

9-32V DC, 10W (start up current - 3Amps for 20mS)

18-60V DC

(Running current 300 - 530mA Dependent upon module configuration)

Unpacking

Carefully remove the ADW15-FPT unit from its packing and ensure that the module configuration code is as ordered (see Chapter 9). Check that the unit, mounting and connection accessories are complete and undamaged.

Equipment

The ADW15-FPT equipment consists of the following:

- I. ADW15-FPT unit
- II. A terminal board to suit the installation
- III. Installation clamps to suit the installation
- IV. Appropriate legend card
- V. Securing screws (These are normally fitted to the installation clamps)

Terminal Boards

Connection between the ADW15-FPT unit and input/output signals, including power supplies, are made via a terminal board at the rear of the unit. Two types of board are available, the choice depending upon the method of unit installation.

Panel and DIN rail terminal boards P and D are shown in Figure 2.1 and 2.3

Figure 2.1 - Fixed Terminal Board (Panel Mounted)

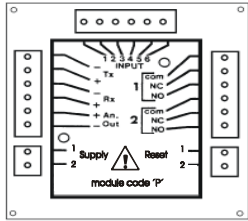

Figure 2.2 - Dimensions For Panel Mounting

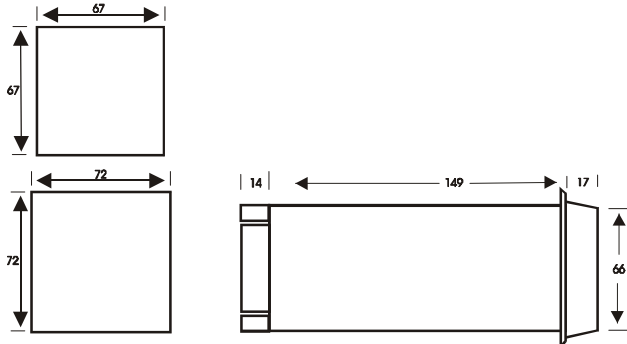

Figure 2.3 - Din Rail Mounted Terminal Board (Din 1 and Din 3)

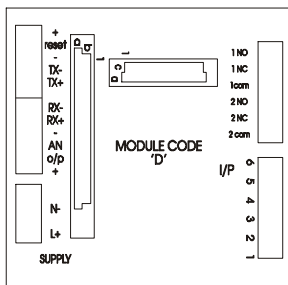
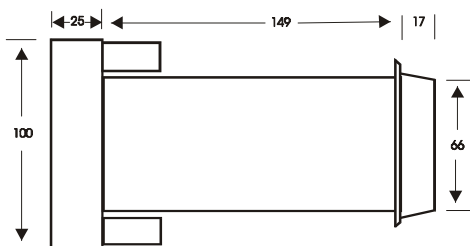

Figure 2.4 - Dimensions of Din Connector



Connecting The Power Supply

Connect power supplies as follows:

- 110 / 240V AC Live to 2
- 110 / 240V AC Neutral to 1
- 9-32V DC Positive to 2
- 9-32V DC Negative to 1
- 18 or 60V DC Positive to 2
- 18 or 60V DC Negative to 1 (Start up current - 3Amps for 20mS)

Connecting The Outputs

1 Analogue Outputs

Connect the analogue output cable to the + and - AN O/P terminals on the terminal board.

NOTE: If it is required to earth the analogue output, it should be done via the -ve terminal.

2 Relay Outputs

a) SPCO relay on SP1

1	COM
	NC
	NO

b) DPCO relay on SP1

1	COM
	NC
	NO
2	COM
	NC
	NO

c) SPCO relay on SP1 & SP2

1	COM
	NC
	NO
2	COM
	NC
	NO

Reset Terminals

3.If a signal is to be used to reset latched relays or Peak /Trough or Auto Tare, it should be connected to the reset terminals. The reset signal must be derived from a volt free contact or NPN transistor. Observing the following limits.

Voltage: 5v dc Positive applies to the contact from the ADW15-FPT
 Current: 5mA Maximum
 Duration: 0.5 seconds Minimum

The reset can also be used for print triggering on printer drive option.

Figure 2.3 - The 4 Wire Strain Gauge

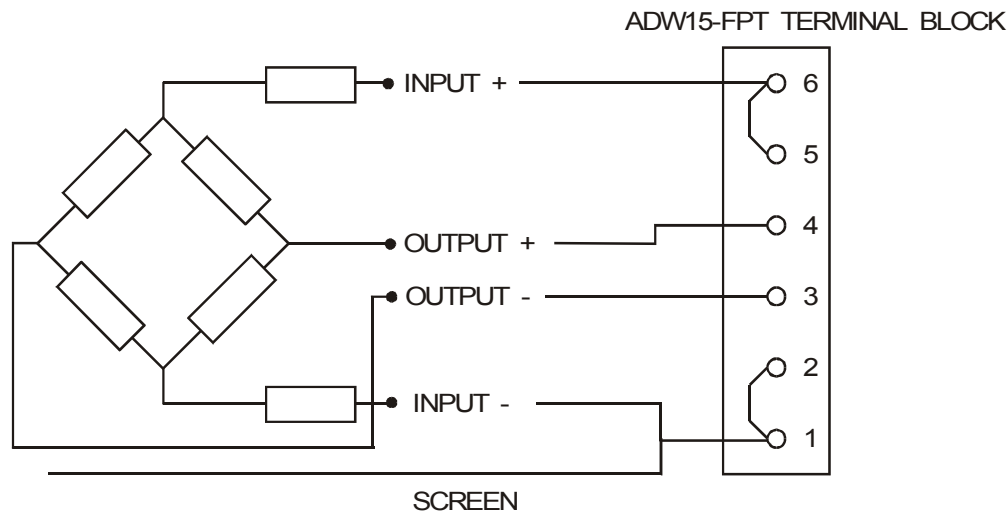
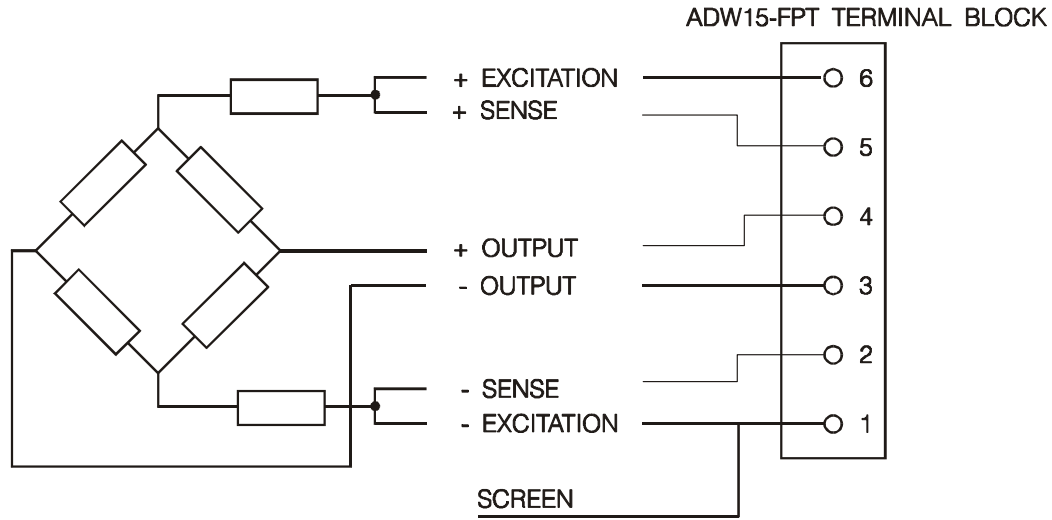

Figure 2.4 - The 6 Wire Strain Gauge



Chapter 3 The ADW15-FPT Controls and Parameters

The Front Control Panel

All user controls, displays and indicators are mounted on the front panel which provides a 4.5 digit, LED display four flush mounted keys and three LED indicators.

Figure 3.1 - Front Panel Layout

The figure below shows the layout. The functions are summarised in table 3.1

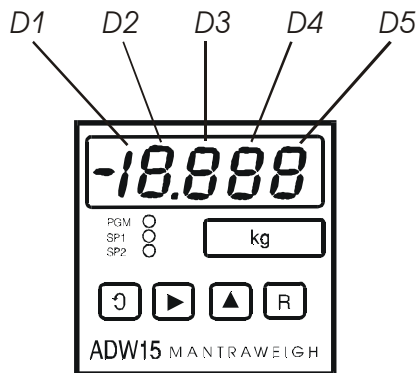



D1 - 1/2 digit	D5 - Decade 4
D2 - Decade 1	SP1 - Set Point 1
D3 - Decade 2	SP2 - Set Point 2
D4 - Decade 3	PGM - Program

Front Control Panel Guide

Table 3.1





Used to scroll through and change the set up data by displaying mnemonics for each configurable parameter, followed by the appropriate data. When in programming mode it should be noted that the first digit in the display may not be visible, but the program indicator light PGM will be flashing to indicate that the instrument is in programming mode, even though no digits can be seen to be flashing.

The  key has a secondary function when not in programming mode. In conjunction with the  key a print function can be initiated. (If a print option is fitted.)



Selects the display digit required. Selection value is indicated by a flashing digit and flashing PGM indicator light.

It also operates as a control key in conjunction with:

- I. The  key for a print function from the rear panel remote
- II. The  key for Peak Hold / Latched Relay Reset
- III. The  key for an Auto Tare function.



Increments each selected display digit 0-9.

Pressing the key under programming conditions will display the leading digit as either 1, -1, or a blank display for zero.

The secondary function operates as a Peak Hold / Latched Relay Reset in conjunction with the  key.



Resets the display to the input variable and enters new data in the ADW15-FPT memory. Returns the display to the current value after Hold.

The secondary function operates an Auto Tare in conjunction with the  key.

NOTE: Secondary functions require the  key to be pressed and released, followed within 1 second by the appropriate function key.

 then  for Print Select

 then  for peak Hold/Latched Relay Reset

 then  for Auto Tare

If during the programming sequence, selection is not completed, the display will revert to the input variable after 2 minutes.

The display module is fitted with 2 security links which, when removed, allows the user to disable keypad programming. (see figure 3.2)

To gain access to the security links a removable fascia is fitted to the case front. This also provides access for fitting the legend label.



Remove link 'A' to disable all four keys. Remove link 'B' (figure 3.2) to disable the  and  keys, allowing all parameters to be viewed but not changed.

Figure - 3.2 Keypad Security Links



IMPORTANT NOTE:

Never fit a link across the two middle pins.

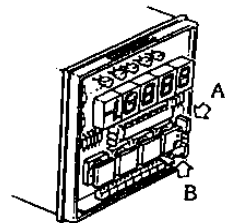
Once the fascia is removed the ADW15-FPT electronics assembly can be withdrawn leaving the case and field wiring in place.

The Configurable Parameters

A series of parameters or programmable functions are provided in the ADW15-FPT to allow the user good flexibility for monitor and control applications.

These parameters are included as constants in the ADW15-FPT database and are accessed and checked via the keypad or the communications port.

Data which is entered by the user is retained by EEPROM for up to 10 years without back up power.

New data, when entered, overwrites previous entries when the  key is pressed unless the EEPROM has been disabled via the communications port.

Password Protection

To prevent unauthorised changes to parameters, other than Set Points and In-Flight compensation settings, a 4 digit password number must be entered. The number is accessed by scrolling through the Set Points and In Flight settings until 'PASS' is displayed. At this point, it is necessary to enter either the factory set number (1111) in D2 - D5 positions, or the password number specifically ordered by the customer.

Chapter 4 Strain Gauge Input to the ADW15-FPT

The Strain Gauge Input

The ADW15-FPT offers a direct connection to most low level (foil) strain gauge sensors. The following example is for calibration of a strain gauge.

A 10 volt excitation is provided and it is monitored to compensate for any variation due to supply drift, load regulation or voltage drop in the cable between the sensor and the ADW15-FPT.

The normal supply current is 150mA which typically allows for the connection of 4 x 350 Ohm strain gauges.

Strain Gauge sensitivity is preset via DIL switches to 0.5, 0.8, 1.0, 1.25, 1.5, 2.0, 2.5, 3.5, 5, 10, 20, 50, 100 and 200mV/V. Select the next value higher than the strain gauge output maximum.

SW1 mV/V	1	2	3	4	5	6	7	8
0.5	x	-	-	x	-	x	x	x
0.8	-	x	x	-	-	x	x	x
1.0	-	x	-	x	-	-	x	-
1.25	-	x	-	-	-	-	-	x
1.5	-	-	x	x	x	-	-	-
2.0	-	-	x	-	x	-	-	x
2.5	-	-	x	-	-	-	-	-
3.5	-	-	-	x	x	-	-	-
5.0	-	-	-	x	-	-	-	x
10.0	-	-	-	-	x	-	-	x
20.0	-	-	-	-	-	x	-	x
50.0	-	-	-	-	-	-	x	x
100.0	-	-	-	-	-	-	-	x
200.0	-	-	-	-	-	-	-	-

x = ON - = OFF

mV/V = \pm mV/V nominal full range gain within \pm 3%

Hardware Configuration:

The ADW15-FPT is supplied set to \pm 2.5mV/V maximum output. To check of the strain gauge and application is within this range, apply the following formula:

$$\frac{\text{Maximum load (weight)} \times \text{strain gauge output voltage}}{\text{strain gauge rated range}}$$

Before any calibration can be set, it will be necessary to decide upon the calibration values and place the decimal point in the appropriate position. To do this, scroll through the parameters, entering the password as appropriate (as described in Chapter 3), until the decimal point parameter is reached (dP-r). Once the decimal point is set, the auto calibration parameters can be set in real engineering terms.

Auto Calibration

Connect the strain gauge, switch on the ADW15-FPT. The display will light up. Allow a warm up period of 10 minutes before carrying out the procedure as follows;

- a) Press the **[ON]** key until PASS appears.
- b) Enter the password using **[▶]** and **[▲]** keys, then press **[ON]** key.
- c) Keep pressing the **[ON]** key until CALL (Cal Low) appears.
- d) Press the **[▶]** key and check that the program light flashes.*

**IMPORTANT NOTE: Always ensure that the programmer indicator flashes, even though the displayed value may not need to change.*

e) Check that the displayed value agrees with the low calibration weight applied to the strain gauge (this may be zero).

If this is not correct, alter the display value by pressing the **[▶]** & **[▲]** keys.

Ensure that the strain gauge is free from disturbance and press the **[ON]** key to capture and calibrate the CALL value.

f) CALH (Cal High) now appears on the display.

g) Press the **[▶]** key and check that the program light flashes.

h) Apply the known higher value weight.

Check that the displayed value agrees with the high calibration weight applied to the strain gauge.

If this is not correct, alter the display value by pressing the **[▶]** & **[▲]** keys.

Ensure that the strain gauge is free from disturbance and press the **[ON]** key to capture and calibrate the CALL value.

Note 1: The Calibration value is not entered into the memory until either the **[R]** key or the **[ON]** key is pressed.

Note 2: CALH must always be greater than CALL, in both weight and entered values.

Note 3: Pressing the **[R]** key at any time will return the display to normal operation.

Note 4: For best accuracy and resolution, the calibration weight should be approximately 75% of the strain gauge capacity.

Note 5: For range check before autocal, set CAL H to 0 and display will be that of the A/D counts. It is important that the A/D span between the CALL weight and CALH weight, is greater than the span of the values entered for CALL and CALH, otherwise the display resolution will not be 1digit.

Note 6: CALH can be set before CALL if required.

Note 7: CALH and CALL can be programmed individually with any time period between provided that the **[R]** reset key is pressed to store the value.

Auto Tare

The auto tare facility allows for any unwanted weight or tare value to be compensated for in the weighing process.

Compensation is achieved by pressing and releasing the **[▶]** key, then within 1 second pressing the **[R]** key.

It is possible to view the Auto Tare value by scrolling to the At mnemonic which will display the offset present in the auto tare mode.

If required Auto Tare can be adjusted to any desired value to give a zero or fixed offset. The unit may also be 'Tared' from the 'Reset' terminals - see dP-r mnemonics in Chapter 3

Display Averaging (dA)

In certain applications, due to the rapid changes in the display, the least significant digits may not be readable. In these cases, the ADW15-FPT readings may be averaged over a number of updates and can be set as follows:

Table 4.1

Display update time

0 = 1 reading (standard)	approx 40mS
1 = 2 readings	approx 80mS
2 = 4 readings	approx 0.16S
3 = 8 readings	approx 0.32S
4 = 16 readings	approx 0.64S
5 = 32 readings	approx 1.28S
6 = 64 readings	approx 2.56S
7 = Fast update mode	approx 10mS

Selection of 'Live', 'Peak' and 'Trough' (Valley) Readings



Any one of these readings can be chosen as the default reading, by the values placed in the (dA) -Display Averaging mnemonics, as follows:-

Default 'live' reading dA = 0-7
+ Live Display averaging value

Default 'Peak' reading dA = 8-15
+ Live Display averaging value

Default 'Trough' (Valley) reading dA = 16-23
+ Live Display averaging value

The values of the three readings, are viewed by pressing the scroll  key, which will show the appropriate value for 2 minutes, after which the display will revert back to the chosen default readings.

A reset of both Peak and Trough are simultaneously made either, from the keypad by pressing and releasing  key followed within a second by  key; or from the reset contact (if set from dp-r) or from a communications command.

Where an Auto Tare value and Peak/ Trough are both operative, it is important to be aware that an Auto Tare function, although activated in the normal way, will zero the input but not the display, which will retain the Peak/Trough value.

Chapter 5 Relay Output Module

General Description

Relay output modules provide output control signals from the default display which can be used for switching functions such as ON/OFF control and alarm indications. The relays are activated by the values programmed for the Set Points. The output configuration will be for open or closed relay contacts and latching.

The relay output module options are as follows:

Table 5.1

Output	Function
1 Relay	SPCO on SP1
1 Relay	DPCO on SP1
2 Relays	SPCO on SP1 or SP2

The connections for which are shown in chapter 2.

Module Functions

The ADW15-FPT can be programmed so that the relay output module reacts to all or any of the following functions:

- Set points
- In Flight compensation
- Hysteresis
- Relay inversion
- Latching

Set Points (SP)

Set points are used to produce output signals at any required value so that the operation of the monitored process can be maintained to preset levels. Any excursion beyond set points will activate the relay or relays, to provide status indications or initiate control as required.

Two set points (SP1) and (SP2) can be programmed to suit different applications. The actions of either or both set points can be inverted if required.

For normal operation the set point output is active until the input reaches the set point level. In this condition when the input value is less than the set point, the SP indicator is on and the output relay is energised producing a closed circuit on a normally open contact. When the set point value is reached, the SP indicator is off and the relay is de-energised producing an open circuit output.

For an inverted operation the reverse conditions apply.

Normal and inverted action is determined by the direction of the input value as it changes.

For example: In alarm applications.

A High-High operation allows for a rising input value to operate on two set points.

A Low-Low operation operates 2 set points on a falling value.

A High-Low operation will operate on a rising or falling value, setting a 'band' by one set point operating normally and the other being an inverted action.

In Flight Compensation

The setting of an In Flight value causes the set points to cut off early to control the flow of the material being weighed.

For example, if SP1 is used to control a flow, a certain amount will be 'In Flight' between the supply point and receiving point causing a positive error when the required weight is reached. The In Flight compensation value is adjusted by the user to 'reduce' SP1 to prematurely stop the flow, allowing the In Flight amount to make up the required total set by SP1. A similar situation exists for SP2.

Hysteresis (HYS)

Once a Hysteresis value has been set, it will be applied to both set points entered. It is effective for both normal and inverted action.

When Hysteresis is applied to set points with normal output action, the input is allowed to rise to the set point value and the output is then turned off. The output is held off until the input value has dropped to the set point minus the Hysteresis value.

For inverted action the input drops to the set point and the output goes off and comes on again when the input rises to the set point plus the Hysteresis value.

Output Action (OA)

The Output Action facility allows the user to determine whether set points produce normal or inverted and latched or unlatched output operation. If an analogue output module is also fitted, the Output Action function determines whether the module's output is inverted or not. The Output Action (OA) is entered by a code to suit the requirements of the user.

Thirty two Output Action options are available.

The value of the OA to be entered in the algebraic sum of the following components:-

SP1 Inverted	= 1
SP2 Inverted	= 2
AN-OP Inverted	= 4
SP1 Latched	= 8
SP2 Latched	= 16

Example 1: If SP1 requires to be latched and inverted and the analogue output is normal, enter $8 + 1 = 9$

Example 2: To invert the analogue output and latch SP2, enter $4 + 16 = 20$

Latching Outputs

The latching facility allows the relay module output to be held until reset externally. Latching is applied to the off status of the relay SP1 or SP2.

Chapter 6 Analogue Outputs

Module Types

Six types of analogue output are available offering three DC current ranges and three DC voltage ranges. These are summarised in the table below.

All outputs are fully linearised, fully scalable, optically isolated and generated from the displayed input value.

Table 6.1 Analogue Output Modules

Output	Range	Module Ref
DC Voltage	0V to 5V	V02
DC Voltage	0V to 10V	V04
DC Voltage	± 10V	V06
DC Current	0 to 1mA	A01
DC Current	0 to 20mA	A02
DC Current	4 to 20mA	A03

Specification for Analogue Outputs Modules A01 & A02

Parameter	Minimum	Typical	Maximum	Units
Zero temperature coefficient	-	0.0007	-	% FSD/ °C
Span temperature coefficient	-	0.0017	-	% FSD/ °C
Resolution	As display resolution	-	15 Bits	-
Linearity	-	-	0.003	% FSD
90 day Stability offset	-	0.0021	-	% FSD
90 day Stability gain	-	0.0017	-	% FSD
Max peak to peak noise	-	-	0.16	% FSD
Operating temperature range	-10	-	50	°C

Module Specific

Speed of response from display to An-op *See note*

To settle within 1% of FS for a step change of 12.5%	-	1.9	-	S
To settle within 10% of FS for a step change of 12.5%	-	0.25	-	S
To settle within 1% of FS for a step change of 100%	-	3.1	-	S

Note: Response values are given from display to analogue.

Output scaling, OPL = -19999, OPH = 19999

Specification for Analogue Outputs Module - A03

Parameter	Minimum	Typical	Maximum	Units
Zero temperature coefficient	-	0.0007	-	% FSD/°C
Span temperature coefficient	-	0.0017	-	% FDS/°C
Resolution	As display resolution	-	15 Bits	
Linearity	-	-	0.003	% FSD
90 day Stability offset	-	0.0021	-	% FSD
90 day Stability gain	-	0.0017	-	% FSD
Max peak to peak noise	-	-	0.5	% FSD
Operating temperature range	-10	-	50	°C

MODULE SPECIFIC

Speed of response from display to An-op *See note*

To settle within 1% of FS for a step change of 12.5%	-	0.37	-	S
To settle within 10% of FS for a step change of 12.5%	-	0.07	-	S
To settle within 1% of FS for a step change of 100%	-	0.8	-	S

Note: Response values are given from display to analogue.
Output scaling, OPL = -19999, OPH = 19999.

Specification for Analogue Outputs Module - V02 & V06

Parameter	Minimum	Typical	Maximum	Units
Output Load Current	0	-	50	mA
Zero temperature coefficient	-	0.0007	-	% FSD/°C
Span temperature coefficient	-	0.0017	-	% FDS/°C
Resolution	As display resolution	-	15 Bits	
Linearity	-	-	0.003	% FSD
90 day Stability offset	-	0.0021	-	% FSD
90 day Stability gain	-	0.0017	-	% FSD
Max peak to peak noise	-	-	0.14	% FSD
Operating temperature range	-10	-	50	°C

Module Specific

Speed of response from display to An-op *See note*

To settle within 1% of FS for a step change of 12.5%	-	1.9	-	S
To settle within 10% of FS for a step change of 12.5%	-	0.25	-	S
To settle within 1% of FS for a step change of 100%	-	3.1	-	S

Note: Response values are given from display to analogue.
Output scaling, OPL = -19999, OPH = 19999.

Specification for Analogue Outputs Module VO4

Parameter	Minimum	Typical	Maximum	Units
Output Load Resistance	5000	-	-	ohms
Output Load Current	-	-	2	mA
Zero temperature coefficient	-	0.0007	-	% FSD/°C
Span temperature coefficient	-	0.0017	-	% FSD/°C
Resolution	As display resolution	-	15 Bits	
Linearity	-	-	0.003	% FSD
90 day Stability offset	-	0.0021	-	% FSD
90 day Stability gain	-	0.0017	-	% FSD
Max peak to peak noise	-	-	0.5	% FSD
Operating temperature range	-10	-	50	°C

Module Specific

Speed of response from display to An-op *See note*

To settle within 1% of FS for a step change of 12.5%	-	0.37	-	S
To settle within 10% of FS for a step change of 12.5%	-	0.07	-	S
To settle within 1% of FS for a step change of 100%	-	0.8	-	S

Note: Response values are given from display to analogue.
Output scaling, OPL = -19999, OPH = 19999.

Output Scaling

Output scaling factors are set by the user and determine the display range over which the analogue module operates.

(OPL) Output Low - This sets the displayed value at the modules minimum output.

(OPH) Output High - This sets the displayed value at maximum output. If the display is outside the range defined by OPL and OPH, the analogue output will remain constant at its minimum or maximum output value.

Example: Assume a 4-20mA output module is required to provide an output of 4mA for 1000Kg and 20mA for 6500Kg. Set OPL to 1000 and OPH to 6500

It will be necessary to determine OPL and OPH by graphical or mathematical means if the known display values do not coincide with the minimum and/or maximum analogue output.

Figure 6.1 Analogue Output

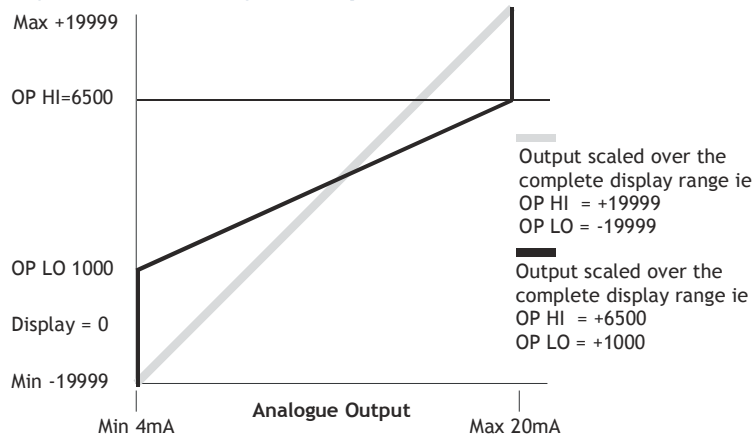
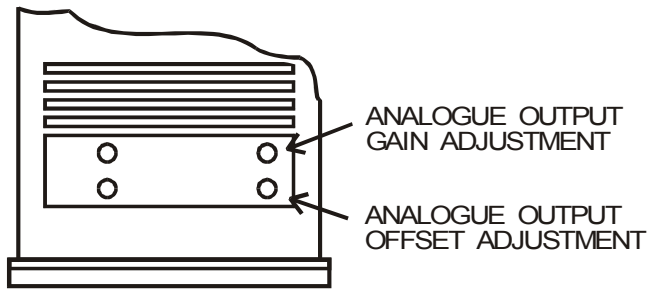

Figure 6.2 - Analogue Output Gain and Offset Adjustment



ADW15-FPT FRONT PANEL

Method of Calculating OPL & OPH from any known output values

OPL = $\frac{\text{Low Display} - (\text{Display span}) (\text{Low output} - \text{Min output})}{(\text{High output} - \text{Low output})}$

OPH = $\frac{\text{High Display} + (\text{Display Span}) (\text{Max output} - \text{High output})}{(\text{High output} - \text{Low output})}$

- Low output = Known low output
- High output = Known high output
- Min output = Lowest measurable value of output module
- Max output = Highest measurable value of output module
- Display span = Highest required display value minus lowest required display value.

Example:

Using a 4.20mA output module where it is required to produce 6mA at a display value of 400 and 18mA at a display value of 1100.

$$\text{OPL} = 400 - \frac{(700)(6 - 4)}{(18 - 6)} = 400 - \frac{(1400)}{12}$$

$$\text{OPL} = 400 - 116.66$$

$$\text{OPL} = \underline{283.34}$$

$$\text{OPH} = 1100 + \frac{(700)(20 - 18)}{(18 - 6)} = 1100 + \frac{(700 \times 2)}{12}$$

$$\text{OPH} = 1100 + 116.66$$

$$\text{OPH} = \underline{1216.66}$$

Note 1: OPH must be greater than OPL

Note 2: If OPL or OPH are greater than ± 19999 then divide both OPL and OPH by 10, this will give less resolution. Decimal point can be placed anywhere to suit reading.

Chapter 7 The Communications Port

Introduction

The ADW15-FPT communications port provides for a 2 way data link. An intelligent host e.g. Personal Computer, Main Frame or PLC is able to acquire the ADW15-FPT's displayed value and read or modify the user configurable parameters.

The communications format is an industry standard 20mA current loop offering high noise immunity and isolation over distances up to 1Km using ASCII or high integrity fast data protocol. In multiple unit applications, the IF25 interface is available providing electrically isolated RS232 compatibility for up to 25 ADW15-FPTs.

In larger installations, multiple IF25's can be combined for expansion up to 254 ADW15-FPT's.

Integrity is ensured by pre-programmed default parameters should a loss of communications with the host occur.

An **RS232/RS485** (link selectable) module provides for one to one, or multidrop facility for up to 245 ADW15-FPTs. This module provides for a printer connection.

Serial Communication Protocol

General

Incoming data is continually monitored by the ADW15-FPT on its serial input line.

Each byte of data is formatted as an eight bit word without parity, preceded by one start bit and followed by one stop bit.

Transmission and reception of data up to 19.2K Baud is possible, the actual rate being selected by an eight-position slide switch on the communications module (of which only 7 positions are used). The Baud rate depends upon the communications, hardware specification, distance and cable type.

MANTRABUS - selected when CP is 128

To signify commencement of a new 'block' of data, the HEX number FFH is used as a 'frame' character, followed by the station number of the unit under interrogation. This is entered via the ADW15-FPT keypad under mnemonic SDSt and ranges from 0-254).

The ADW15-FPT acts upon incoming data only if its own station number immediately follows the FFH character. New data must be received as a string of four nibbles (bits 7-4 set to zero) which are assembled into two bytes and written into the variables store within the ADW15-FPT. The most significant nibble must be received first and the last nibble must have the most significant bit (bit 7) set to indicate the end of data. This is followed by the checksum. The data transmitted from the ADW15-FPT is always sent as complete bytes. The station number precedes the data and the checksum follows the data. The data format used is signed 15 Bit. The most significant Bit of the most significant Byte is set for negative numbers.

Operation

There are two modes of operation, namely data requests by the host controller and data changes. Data requests from the ADW15-FPT consist of either a complete dump of the data variables stores in RAM or the display reading. Data changes consist of writing new data to ADW15-FPT variables, thus changing parameters such as Set Points, in flights etc.

An acknowledgement message is returned to the ADW15-FPT to indicate that the new data has been acted upon.

Updating

The required mode or variable to be updated is determined by the station number followed by the command byte. An EXOR checksum consisting of the station number command byte and any following data must be appended to the received data. It is most important that the byte preceding the checksum must have its most significant bit set to signify the end of data.

The ADW15-FPT works out its own checksum and, if it disagrees with the received one, a not acknowledge (NAK) message is returned.

Communications Commands

The following is a list of commands available for reading to or writing from the ADW15-FPT.

Command No.

DEC	HEX	Description
0	0	REQUEST PEAK/THROUGH AND LIVE DISPLAYS
1	1	REQUEST ALL DATA INCLUDES WEIGHT INPUT
2	2	REQUEST DISPLAY DATA
3	3	UPDATE SET POINT 1 (SP1)
4	4	UPDATE IN-FLIGHT 1 (IF1)
5	5	UPDATE SET POINT 2 (SP2)
6	6	UPDATE IN-FLIGHT 2 (IF2)
7	7	UPDATE HYSTERESIS (HYS)
8	8	UPDATE OUTPUT ACTION (OA)
9	9	RESERVED
10	A	RESERVED
11	B	RESERVED
12	C	RESERVED
13	D	UPDATE AUTO TARE (At)
14	E	UPDATE DISPLAY AVERAGES AND HOLD FUNCTION (dA)
15	F	UPDATE OUTPUT LOW (OPL)
16	10	UPDATE OUTPUT HIGH (OPH)
17	11	UPDATE DECIMAL POINT AND RESET FUNCTION (DP r)
18	12	CAN NOT BE WRITTEN TO, AND ADW WILL RETURN A NAK (SDSt/CP) EEPROM
19	13	ENABLE/DISABLE
20	14	OUTPUT RELAY RESET
21	15	AUTO TARE
22	16	PEAK HOLD RESET

Command 0 Request Peak/Trough and Live Displays:

Data transmission to ADW15-FPT for Command 0, 0FFH, Station Number, 080H, CHKSUM.

Where CHKSUM = Station Number EXOR with 80H

Example: To obtain Live, Peak/Trough value of the ADW15-FPT whose Station Number is 47 send the following data:-

0FFH, 02FH, 080H, 0AEH

 |
 Note MS Bit Set

DATA TRANSMITTED TO ADW15-FPT FOR COMMAND

Response to Command 0

BYTE

1	Station Number
2,3	Live reading
4,5	Peak reading
6,7	Trough reading
8	EXOR CHKSUM of above data

Command 1 Request for All Data:

DATA TRANSMITTED TO ADW15-FPT FOR COMMAND 1

0FFH, Station Number, 081H, Chksum

Where Chksum = Station number EXOR with 081H.

Example: To obtain a complete dump of the variables in the ADW15-FPT whose Station number is 47 send the following Data:-

0FFH, 02FH, 081H, 0AEH

|
Note MS Bit Set

Response To Command 1 From ADW15-FPT

BYTE

1	Station number
2,3	DISPLAY SELECTED DEFAULT
4,5	SET POINT 1
6,7	IN FLIGHT 1
8,9	SET POINT 2
10,11	IN FLIGHT 2
12,13	HYSTERESIS
14,15	OUTPUT ACTION
16,17	A/D COUNTS FOR LOW CALIBRATION POINT
18,19	A/D COUNTS FOR HIGH CALIBRATION POINT
20,21	DISPLAY LOW CALIBRATION VALUE
22,23	DISPLAY HIGH CALIBRATION VALUE
24,25	AUTO TARE
26,27	DISPLAY AVERAGING
28,29	OUTPUT LOW
30,31	OUTPUT HIGH
32,33	DECIMAL POINT POSITION
34,35	STATION NUMBER
36	EEPROM ENABLE/DISABLE FLAG
37	RELAY STATUS
38	EXOR CHECKSUM OF THE ABOVE DATA

NOTE: Most significant byte precedes least significant byte for data sent by ADW15-FPT.

Command 2 Request Display Data

DATA transmitted to ADW15-FPT for Command 2.

0FFH, Station number, 082H, Chksum

Where Chksum = Station number EXOR with 082H

Example: To obtain the display reading of an ADW15-FPT whose station number is 47 send the following Data:

0FFH, 02FH, 082H, 0ADH

|
Note MS Bit Set

Response To Command 2 from ADW15-FPT

BYTE

1. Station No.
2. Display reading M.S. Byte. Selected default display
3. Display reading L.S. Byte.
4. EXOR checksum of above data and Station No.

If, when using commands 1 or 2, an error is detected by the ADW15-FPT then the Not Acknowledgement string is transmitted by the ADW15-FPT.

Commands 3 TO 18: Write data to ADW15-FPT Parameter

Commands 3 to 18 all have the same format.

Format for data transmitted to ADW15-FPT for Commands 3 to 18:-

OFFH, Station No, Command No, MSN, NMSN, NLSN, LSN, CHKSUM

Where MSN = Most significant nibble of data

NMSN = Next most significant nibble of data

NLSN = Next least significant nibble of data

LSN = Least significant nibble of data with MSBIT set

CHKSUM = The following EXOR'd with each other, Station number, command number, MSN, NMSN, NLSN, LSN with MSBIT set

Example: To change SP1 to 200.0 on an ADW15-FPT whose station number is 47. The following data is sent.

Please note the following points apply:-

1. The decimal point is ignored i.e. 200.0 equals 2000 digits
2. The data is sent in Hex nibbles so 2000 = 00H, 07H, 0DH, 00H

OFFH,02FH, 03H, 00H, 07H, 0DH, 80H, 0A6H

|
Note MSBIT set

Response to Command 3 to 22

If the data has been accepted by the ADW15-FPT then the following acknowledgement string is transmitted by the ADW15-FPT.

Station number, 06H (ACK)

If there are any errors with the data received by the ADW15-FPT then the following Not Acknowledgement (NAK) string is transmitted by the ADW15-FPT:-

Station number, 015H (NAK)

Command 19: EEPROM Enable / Disable

The EEPROM disable facility can be used for any of the following:
cycles to EEPROM to limit degradation.

- I. To limit the number of write cycles to EEPROM reducing degradation.
- II. Change data in the ADW15-FPT RAM only, allowing EEPROM to hold power up values.
- III. Leave base constants in the EEPROM for later update to RAM which allows manipulation of the data before writing to the RAM.

Writing new data from the RAM to the EEPROM.

EEPROM disable is achieved by writing 0100H to the ADW15-FPT via command 19. In this state all writing to, or reading from the EEPROM is inhibited.

The EEPROM can be re-enabled in two ways:

By writing 0200H via command 19.

This writes the current contents of the variables store in the ADW15-FPT into the EEPROM.

By writing 0400H via command 19.

This updates the variables store from the current contents of the EEPROM.

Examples

To disable the EEPROM on an ADW15-FPT whose Station number is set to 47

0FFH 02FH 013H 00H 01H 00H 080H 0BDH

To re-enable the EEPROM and update the RAM with the old EEPROM constants:

0FFH 02FH 013H 00H 04H 00H 080H 0B8H

To re-enable the EEPROM and update it with the new RAM data:

0FFH 02FH 013H 00H 02H 00H 080H 0BEH

For response see 'Response to Command 3 to 22'.

Command 20: Output Relay Reset

DATA transmitted to ADW15-FPT for Command 20

0FFH, Station number, 094H, CHKSUM

Where CHKSUM = Station Number EXOR with 094H

Example: To output a relay reset to an ADW15-FPT whose Station Number is set to 47

0FFH, 02FH, 094H, 0BBH

|
Note MS BIT SET

For response by ADW15-FPT see 'Response to Commands 3 to 22'

Command 21: Auto Tare

DATA transmitted to ADW15-FPT for Command 21

0FFH, Station number, 095H, CHKSUM

Where CHKSUM = Station Number EXOR with 095H

Example: To output an Auto Tare command to an ADW15-FPT whose Station Number is set to 47

0FFH, 02FH, 095H, 0BAH

|
Note MS BIT SET

For response by ADW15-FPT see 'Response to Commands 3 to 22'

Command 22: Peak Hold Reset

DATA transmitted to ADW15-FPT for Command 22

0FFH, Station number, 096H, CHKSUM

Where CHKSUM = Station Number EXOR with 096H

Example: To output a Peak Hold reset to an ADW15-FPT whose Station Number is set to 47

0FFH, 02FH, 096H, 0B9H

|
Note MS BIT SET

For response by ADW15-FPT see 'Response to Commands 3 to 22'

Example of a Basic Code to Communicate with MANTRABUS

open the serial port with no handshaking

```
OPEN"COM2:4800,N,8,1,RS,DS,BIN" FOR RANDOM AS#1
```

request display from device 1

<i>Frame FF</i>	<i>Station No</i>	<i>Command 2</i>	<i>Checksum of</i>
	1	And add 80 hex to this byte as it is the last before as the checksum	all bytes except frame

```
talk$=CHR$(&HFF)+CHR$(&H1)+CHR$(&H82)+CHR$(&H1 XOR&H82)
```

print the string to the port

```
PRINT#1,talk$;
```

(must add semicolon after string to stop transmitting a carriage return)

wait for a while (this depends on how many bytes you are expecting and the baud rate!)

input all the bytes in the serial buffer

```
input.from.adw-fpt$=INPUT$(LOC(1),#1)
```

ASCII Format - selected when CP is 129

The serial data to and from the ADW15-FPT is formatted as eight bit words with no parity preceded by one start bit and followed by one stop bit. The baud rate (up to 9.6k Baud) is selected on the COMMS module. All communications are carried out using the standard ASCII character set. Incoming line feeds and spaces are ignored; upper and lower case letters are permitted. The incoming data is continually monitored for Carriage Return characters (Chr\$13D). If one is received the next three characters (000 - 999) are compared with the ADW15-FPT station number (SDST) previously entered via the keypad. N.B. leading zeros must be included. If no match is found the data that follows is ignored.

The next characters received (up to 4 max) are decoded as the 'label', ie. which variable in the ADW15-FPT is to be acted upon. If the label is received incorrectly and cannot be decoded the ADW15-FPT will return a '?' followed by a C.R. character. If the received label is followed by a C.R. the ADW15-FPT will return the current value of the variable in question. (Because there is no hardware handshaking, all transmission from the ADW15-FPT is performed one character at a time upon receiving a Null character (Chr\$0) prompt from the Host system. Thus for every character transmitted a prompt character is required.) The output from the ADW15-FPT is an ASCII string of sixteen characters the last one being C.R.

The first four characters are the Station No. (with leading zeros if necessary) followed by a space. The label then follows with spaces added if required to make a total of four characters. The next seven characters is the numerical value of the required variable with polarity, spaces, d.p. and leading zeros added as required.

If the received label is followed by an '=' character the ADW15-FPT accepts the following numerical data (which must be terminated by a C.R.) and updates the variable in question and returns a C.R. character to the host when prompted. Data input is reasonably flexible. If all five digits are entered, no decimal point need be included. If less than five digits are entered with no decimal point then the last digit is assumed to be the units.

Under normal circumstances the EEPROM in the ADW15-FPT continually refreshes the working RAM. However, it can be disabled via the serial input, by sending the instruction 'DROM = 256' after the Station No. In this condition all read/write operations to or from the EEPROM are inhibited. There are two instructions which will re-enable the EEPROM:

- 1) 'ERRD' - this performs a read from the EEPROM and updates the working RAM with the contents of the EEPROM.
- 2) 'ERWR' - this instruction writes the new RAM values into the EEPROM.

In both cases the EEPROM continues to refresh the RAM.

Instruction Set for ASCII Serial Communications

Request for data:

DATA sent to ADW15-FPT

Data returned from ADW15-FPT

CR xxx	DISP	CR	xxx 'SPACE'	DISP	YYYYYY CR
Station No.	label		Station No.	label	numerical value
CR xxx	DOSP	CR	xxx 'SPACE'	DOSP	'SPACE' ? CR
Station No.	incorrect label		Station No.	incorrect label	

DATA sent to ADW15-FPT

Data returned from ADW15-FPT



CR xxx		SP1 = 100.0	CR
Station No., label		numerical value	
CR xxx		SP3 = 100.0	?CR
Station No.,		incorrect label,	numerical value.

Table 7.1

Labels	Description
DISP	REQUEST DISPLAY READING
SP1	SET POINT 1 (SP1)
IF1	IN-FLIGHT 1 (IF1)
SP2	SET POINT 2 (SP2)
IF2	IN-FLIGHT 2 (IF2)
HYS	HYSTERESIS(HYS)
OA	OUTPUT ACTION (OA)
At	AUTO TARE(At)
DA	DISPLAY AVERAGES (dA)
OPL	OUTPUT LOW (OPL)
OPH	OUTPUT HIGH (OPH)
DP	DECIMAL POINT (dP r)
SDST	CAN NOT BE WRITTEN TO (SDST/CP)
DROM	DISABLE EEPROM (DROM = 256)
ERRD	ENABLE EEPROM AND READ FROM IT
ERWR	ENABLE EEPROM AND WRITE TO IT
RLYS	OUTPUT RELAY STATUS (0 = BOTH OFF, 1 = RELAY 1 ON, 2 = RELAY 2 ON, 3 = BOTH RELAYS ON)
RES	OUTPUT RELAY RESET
TARE	AUTO TARE
PKR	PEAK HOLD RESET

ADW15-FPT15 Printer Format

(CP must be set between 0 - 127)

Printer selection enables the ADW15-FPT15 to print its current display value to a printer via its communications port. This display value can either be assigned a date and time stamp and/or a log number depending on the user set options entered under mnemonic 'CP'. The log number can be reset or preset using the mnemonic 'Ln'. This value is not saved on power fail. A label can be suffixed to the printed display value using the mnemonic 'LAB'. A large range of labels are available to the user. To initiate the printer function press the  key followed within 1 second by the  key. The printer function can also be initiated from remote contact by adding 32 to dP r.

The time and date are set in the TDP printer itself using its own menu. The printer allows the entry of an additional custom text message.

Three connections are required between the ADW15-FPT communications port and the printer with a maximum cable length of 100 metres. (See Chapter 8 for Details)

All standard ADW15-FPT options are available with the exception of the communications modules, which cannot be connected when the printer option is used.

Additional Mnemonics for the Printer Operation:

When the printer option is fitted further mnemonics are included in the normal range. After the dP r mnemonic are the following:-

CP At this mnemonic the printer type and print format number is selected. This number being appropriate to the type of printer used. Details are advised with each type of printer selected.
Present types available are:- For the ITT IPP-144-40E printer the following numbers apply

0 Prints a sequential log number with the current display and unit of measure
e.g. **00014 0011.3 tonne**

1 Prints date and time with a sequential log number, current display and unit of measure
e.g. **00015 0001.7 tonne**
22.05.06 12:05:06

2 Prints a sequential log number, current display, unit of measure with customer text message No 1
e.g. **MANTRACOURT ELECTRONICS ADW15-FPT15 PRINTER**
00012 000.2 tonne

3 Prints date and time with a sequential log number, current display, unit of measure and a customer text message No.1
e.g. **MANTRACOURT ELECTRONICS ADW15-FPT15 PRINTER**
00013 0023.6 tonne
05.03.06 12:03:04

4-7 Digitec 6700 series

8,9 Amplicon AP24 and AP40

Eltron LP2142 - (The label file must be called 'MEL' and the label must contain a LOG NUMBER, THE DISPLAY VARIABLE & a LABEL (not zero).

12 ASCII string on print command

127 Continuous ASCII stream of the display data, transmitted on every display update

Note:1 9 gives an inverted print out

Note:2 it is anticipated that further types of printer will be added, and additional numbers will be allocated as appropriate

LAB Label Number

A number can be selected for the appropriate unit of measure. See table below:

Note: 0 = NO LABEL

0	BLANK			
1	Deg R	18 m	35 ton	52 RPM1000
2	Deg C	19 in	36 %Dev	53 Hz
3	Deg F	20 ft	37 W	54 kHz
4	Kelvin	21 degrees	38 kW	55 V DC
5	lb/in2	22 L/s	39 MW	56 mV DC
6	bar	23 L/min	40 pH	57 A DC
7	mbar	24 L/h	41 ppm	58 mA DC
8	kPa	25 gals/s	42 uS	59 V AC
9	atm	26 gal/min	43 Ohms	60 mV AC
10	mmHg	27 gal/h	44 m/s	61 A AC
11	inHg	28 %RH	45 ft/min	62 N
12	inH2O	29 gram	46 RPM	63 spare
13	cmHg	30 kg	47 RPMx10	64 spare
14	mm	31 lb	48 RPMx100	65 spare
15	Wh	32 kWh	49 cos @	66 spare
16	Db	33 mile/h	50 km/h	67 knots
17	tonne	34 %		68 s
			51 ms	

Ln Log Number

A range of numbers 0 to 19,999 is available. Any sequential number logging activity can be preset as desired, between these numbers. The number will reset to zero after 19,999. The log number is not saved on power fail and resets to zero on power up.

Provision is made in the ADW15-FPT for communications via one of two module options:

SO1 The 20m Amp current loop module, for connection to an IF25 interface.

Com 1 An RS232/485 isolated module, for connection to a Printer PC or PLC, in a single or multiple function

Figure 7.1 - Com 1 - Isolated RS232/485 Communications Module

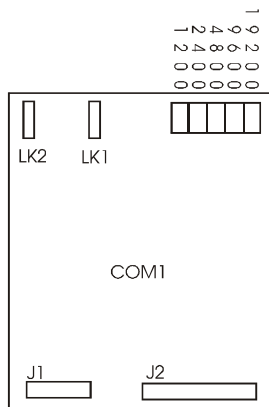

RS485 Mode Connections

Note: When multidropping, the last device should be terminated with 120R, by fitting link LK2 on the COM1 modules.

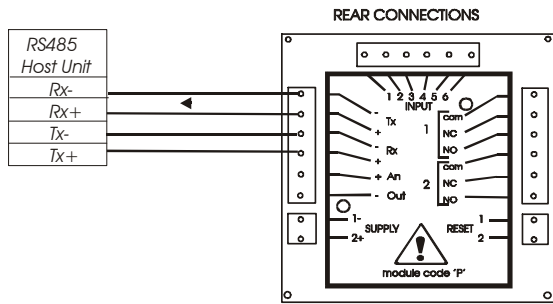

Figure 7.2 - Connecting Multiple Units On RS485

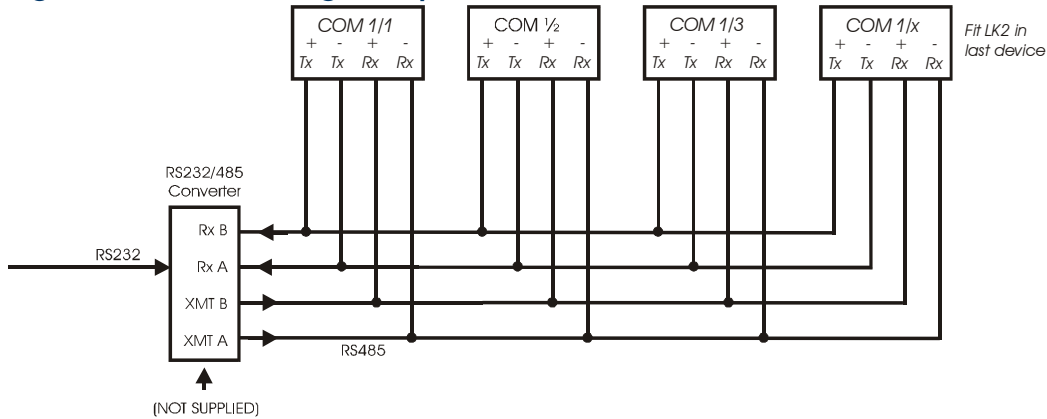

Figure 7.3 - RS232 Mode To PC

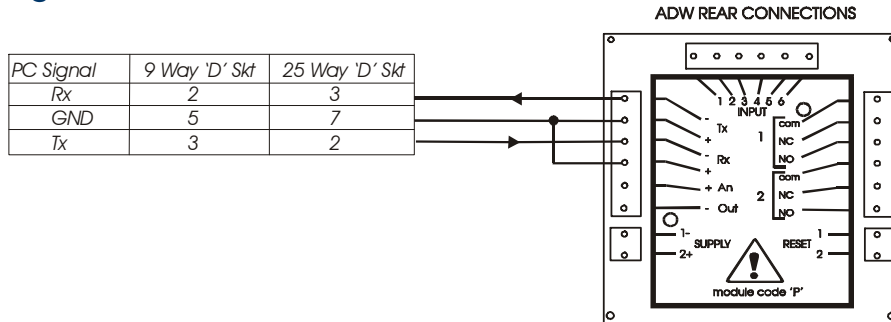
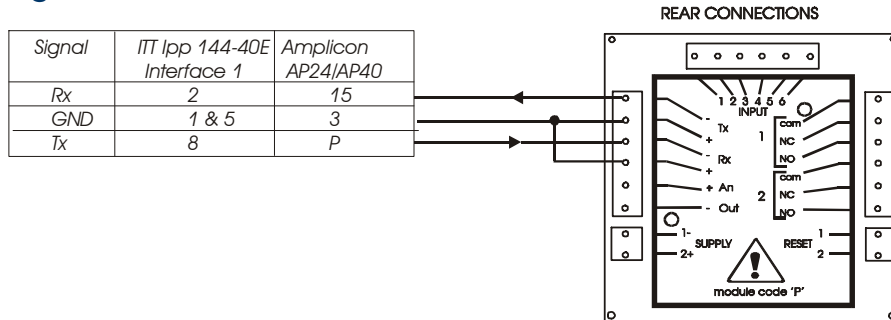

Figure 7.4 - RS232 Mode To Printer



Note: LK1 must be made for RS232 operation

NOTE: When using an RS232 to RS485 converter which has a non-biased receiver, the following actions are recommended:-

To bias the device:

1. Terminate the receiver with 140R in place of the usual 120R
2. Fit a 1.5K from the receive negative to the receiver +5V supply, or a 3K3 to the +12V supply.
3. Fit a 1.5K from the receive positive to the receiver supply Ground.

SO1 - 20m Amp Current Loop Communications Module:

The current loop module makes provision for the connection of up to 25, ADW15-FPT15 units to the IF25 current loop interface unit which can then be connected via an isolated RS232 port, to the host controller PC or PLC. All ADW15-FPT15 transmit connections are paralleled with receive inputs connected in series.

Expansion is achieved by the provision of further IF25 units; for the connection of up to 254 separate instruments. **SO1 (Current Loop) & RS232**

Table 7.2

Position 1 = 300	
Position 2 = 600	
Position 3 = 1200	
Position 4 = 2400	
Position 5 = 4800	
Position 6 = 9600	
Position 7 = 19200.	(MANTRABUS ONLY)

Figure 7.5 - Connecting Multiple ADW15-FPTs

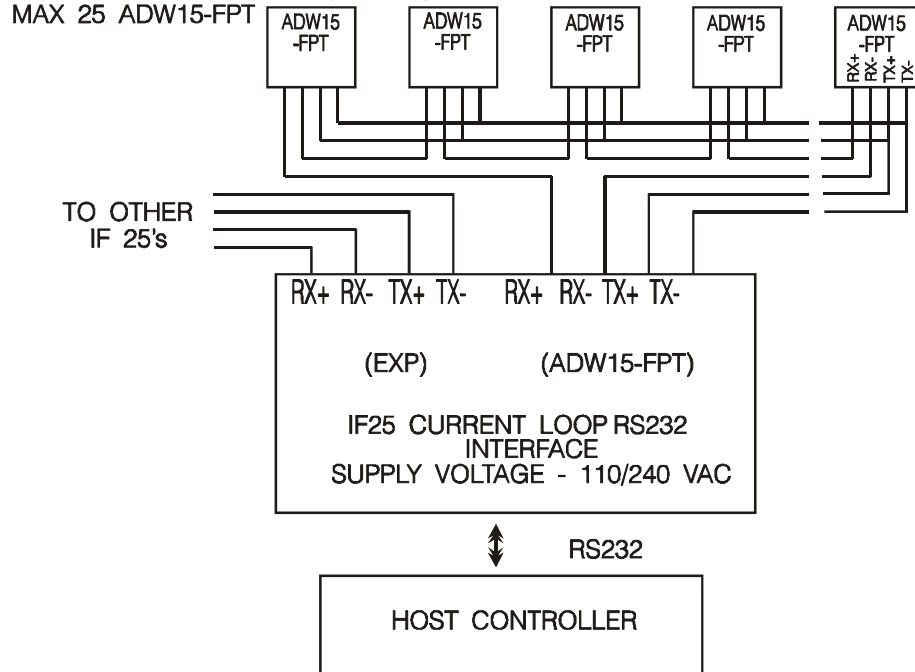

Connecting Multiple ADW15-FPTs to the IF25 Interface

Notes

- 1) Maximum loop voltage is 50V dc.
- 2) Loop is isolated from host and ADW15-FPTs. Loop should be earthed via Rx - on IF25/254
- 3) IF25 used for up to 25 ADW15-FPTs.
- 4) At 19,200 Baud, max. cable length is 100m metres, using cable type BICC H8085.

Chapter 8 Trouble Shooting Guide

This chapter is designed to assist in the identification of problems relating to the installation and setting up of the ADW15-FPT.

1. General Connection and setup parameters.

No display on power up.

- a) Check supply is present at the ADW15-FPT terminals.
- b) If supply is correct contact your Distributor.

Display shows (-1 or 1) continually, without a weight applied to the strain gauge.

- a) Check input connections to the ADW15-FPT from the strain gauge.
- b) If connecting a 4 wire device ensure terminals 1&2 and 5&6 are linked.
- c) Check strain gauge output between input terminals 3&4 of the ADW15-FPT.
- d) Check that the CALH weight is applied and is not the same or lower than CALL

Display over ranges (-1 or 1) when, or before, the maximum required weight is applied to the strain gauge.

- a) Check output of strain gauge is set to the correct sensitivity settings on the DIL switch

Display very noisy

- a) If using a 4 wire device ensure terminals 1&2 & 5&6 are linked.
- b) Check output voltage of strain gauge.
- c) Check stability by shorting 3&4 of the input - Display to read '0000'

Display operating in wrong direction

- a) Check connections to input terminals 3&4 are correct way round.
- b) Check the type of strain gauge - compression or tension.

CALH will not accept its value

- a) Check strain gauge is not reversed. Making CALL larger than CALH (A to D reversed)

Unit will not auto calibrate

- a) Check that CALH is not zero and its weight is greater than CALL.
- b) Check that input is not overranged on CALH weight - by the setting of the sensitivity settings on the DIL switch

Unit will not auto tare

- a) Check DP r code for correct setting.
- b) Check auto tare sequence, when selected from keypad, is completed within 1 second.

Access to parameters not possible beyond the PASSWORD (PASS)

- a) Check for special password (1111)

Front panel keys do not function

- a) Ensure both links 'A' and 'B' are fitted to display module. Refer to chapter 3 Keypad security links.

Unable to enter data using key and key.

- a) Ensure link 'B' is fitted to display module.

2. Relay Output Module

Incorrect Relay Operation

- Check set point, in flight and hysteresis values are correct.
- Check latching and inversion settings in output action (OA) are correct.
- Check connections to output terminals.

Remote function (Auto Tare, Peak Hold / Latched, printer fails to operate)

- Check 'DP-r' for correct value to ensure desired function selected.
- Check connections to 'remote' terminals.

3. MANTRABUS/ ASCII Format

No Communications

- Check that a comms module is fitted.
- Check correct CP code is entered for required protocol.
- Check connections to ADW15-FPT from IF25 are correct.
- Check IF25 green LEDs are on and RX LED is on and TX LED is off.
Press TX TEST, TX LED should light.
- Check RS232 connections from the host to the IF25 are correct.
- Check SdSt, serial device station number is correct.
- Check Baud rate settings on ADW15-FPT's are correct for the host.
- Check host comms port is set to 8 bit word, 1 start bit, 1 stop bit, no parity.
- Check correct protocol is being observed by the host.

Figure 8.1 ADW15-FPT Board Layout

ADW15-FPT INTERNAL LAYOUT (TOP VIEW)

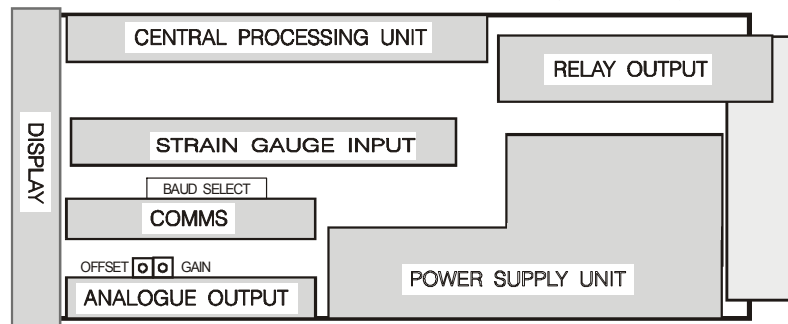

Chapter 9 ADW15-FPT Specifications

Strain Gauge Input

Calibration	Automatic digital by use of keypad and 1 (or 2) known weights. Manual calibration can also be selected.
Auto Tare	By pressing ▲ and ■ keys, display will zero. Auto tare values can also be viewed and manually changed if required. Auto tare value is retained on power down. Auto Tare can also be affected from the 'remote' rear terminals using dP r.
Sensitivity Range	± 0.5 to 200mV/V (Factory set to nom 2.5mV/V) (DIL switch selectable) Pre set to $\pm 2\%$
Excitation	10V DC nominal, 150mA maximum
Compensation	By \pm sense wires to compensate for cable, connection volt drops and any variation in 10V supply.
Accuracy after user Autocal	90 days $\pm 0.08\%$ of reading and $\pm 0.05\%$ of FSD typical
Temp. Drift	0.002% /C typical @ 2.5mV/V
Display Rate	Keypad selectable between 0.01 and 25.6 seconds.
Display Average	Set by keypad, up to 64 standard updates
Display	1 x 4.5 digit, high brightness, 10mm red LED 2 x 3mm LED's for SP1 and SP2 status 1 x 3mm LED for hold
Frequency Response (From input to display value)	3 db point = 13.5Hz

DC Analogue Outputs

Order Code	Range Minimum	Range Maximum	Max Drive Capability	Typical % of reading	Accuracy % of FSD
A01	0	+1mA	20V (20K)	$\pm 0.08\%$	$\pm 0.08\%$
A02	0	+20mA	20V (1K)	$\pm 0.08\%$	$\pm 0.08\%$
A03	4	20mA	20V (1K)	$\pm 0.08\%$	$\pm 0.08\%$
V02	0	+5V	50mA	$\pm 0.08\%$	$\pm 0.08\%$
V04	0	+10V	50mA	$\pm 0.08\%$	$\pm 0.08\%$
V06	-10	+10V	50mA	$\pm 0.08\%$	$\pm 0.08\%$

Speed of Response from Display to Analogue Output

To settle within 1% of full scale for a step change of 12.5%	= 350ms
To settle within 10% of full scale for a step change of 12.5%	= 50ms
To settle within 1% of full scale for a step change of 100%	= 800ms

Control / Alarm Relay Outputs

Order Code	Function
R01	1 SPCO relay on SP1
R02	1 DPCO relay on SP1
R03	2 SPCO relays, SP1 and SP2

Contact Rating 240V @ 5A AC

Setpoint, In Flight Compensation, Hysteresis, Latching and Relay Inversion are set digitally using keypad and display, in engineering units.

Hysteresis value applies to both SP1 and SP2. (Fail safe operation by setting inversion to give normally energised operation).

Latching Reset By volt free contact to rear terminals or by communication

The Communications Port Data

Operation

All ADW15-FPT display data can be retrieved via communications port along with relay and EEPROM status.

All ADW15-FPT user configurable data can be changed including EEPROM enable/display and relay reset. (ADW15-FPT Station Number cannot be changed).

Order Code	Connection	4 wire for 2 x 20mA isolated transmit and receive loops
CP	Cable length	Up to 1km (depending on baud rate and cable used)
	Baud Rates	300, 600, 1200, 2400, 4800, 9600 (19200 CP1 version)
	Isolation	±130V RMS or DC max to analogue input or any other port
	RS232 to 20mA IF25 Interface	Connection to RS232 via separate IF25 interface which will support up to 25 ADW15-FPTs. Up to 10 IF25s can be directly wired together to support 250 ADW15s from 1 RS232 port RS232/485 for connection of up to 25 ADW15 units on a single RS485 line or single one to one RS232 line.

Data Retention and Protection

Retention: 10 years for set values, minimum of 10,000 write cycles, but typically 1,000,000.

Protection of data and function(s): Watchdog timer giving repeat auto resets. Impending power fail detection and shutdown. Low power detection and hold off.

Keypad Security

Keypad 4 membrane keys with tactile feedback

Security -There are 2 levels of security built in:

- 1) Password to protect access to all data after SP1, IF1, SP2 and IF2
- 2) Keypad disable either totally or to enable viewing of SP1, SP2 and In Flight values only by removal of links behind front panel.

CE Approvals

European EMC Directive 2004/108/EC
BS EN 61326-1:2006
BS EN 61326-2-3:2006

Low Voltage Directive 2006/95/EC
BS EN 61010-1:2001
Rated for Basic Insulation
Normal Condition
Pollution Degree 2
Permanently Connected
Insulation Category III

Physical

Case dimensions 72 x 72 x 163mm (Excl. mounting terminals)

Case materials Grey Noryl, flame retardant

750g

Weight

2.5mm, saddle field terminals

Terminals All electronics removable through front panel leaving wiring
and case in situ.

Accessibility

Mounting Options

Order code

P Panel Mount to fit 67 x 67mm cut out (DIN43780)

D DIN rail mounting (G or top hat profile)

Power Supplies

Order code

W240 210 - 260v AC, 50 - 60Hz, 10W

W110 97 - 120v AC, 50 - 60Hz, 10W

W12/24 9 - 32v DC, 10W, provides electrical isolation

ADW15-FPT Order Codes

Input	Standard Strain Gauge		10v DC / 150mA	
Outputs	Analogue	Output	Range	Order code
		NONE		0
		DC voltage	0v to 5v	V02
		DC voltage	0v to 10v	V04
		DC voltage	±10v	V06
		DC current	0 to 1mA	A01
		DC current	0 to 20mA	A02
		DC current	4 to 20mA	A03
Communications Port	None		0	
	Current Loop		S01	
	Communications RS232/485		COM1	
Outputs	Control/Alarm Relay	Output	Function	Order Code
		1 Relay	SPCO on SP1	R01
		1 Relay	DPCO on SP1	R02
		2 Relays	SPCO on SP1 or 2	R03
Supplies		220 - 240v AC 50 - 60Hz 10W		W240
		110 - 120v AC 50 - 60Hz 10W		W110
		9 - 32v DC 10W		W12/24
Terminal Panel		Panel mount		P
		DIN rail mount		D
		IP65 panel gasket		/G

Example: ADW15-FPT-A03-CP2-R01-W240-P

ADW15-FPT Accessories

The following accessories are available to allow for expansion of systems:

	Function	Order Code
IF25 Interface NOTE: Details of the unit appears in a separate publication	Connect up to 25 ADW15-FPTs	IF25
Printers	Time / date and display data Display data only	TDP DP

WARRANTY

All ADW-FPT products from Mantracourt Electronics Ltd., ('Mantracourt') are warranted against defective material and workmanship for a period of (3) three years from the date of dispatch.

If the 'Mantracourt' product you purchase appears to have a defect in material or workmanship or fails during normal use within the period, please contact your Distributor, who will assist you in resolving the problem. If it is necessary to return the product to 'Mantracourt' please include a note stating name, company, address, phone number and a detailed description of the problem. Also, please indicate if it is a warranty repair.

The sender is responsible for shipping charges, freight insurance and proper packaging to prevent breakage in transit.

'Mantracourt' warranty does not apply to defects resulting from action of the buyer such as mishandling, improper interfacing, operation outside of design limits, improper repair or unauthorised modification.

No other warranties are expressed or implied. 'Mantracourt' specifically disclaims any implied warranties of merchantability or fitness for a specific purpose. The remedies outlined above are the buyer's only remedies. 'Mantracourt' will not be liable for direct, indirect, special, incidental or consequential damages whether based on the contract, tort or other legal theory.

Any corrective maintenance required after the warranty period should be performed by 'Mantracourt' approved personnel only.



CE *In the interests of continued product development, Mantracourt Electronics Limited reserves the right to alter product specifications without prior notice.*

Code No. 517-086

Issue 2.6

21.01.10